

SKOFF



MUSIC LINE
SENSOR & LIGHT

SKOFF DESIGN

Information / Informacje / Informationen

4-9

TANGO

11  **Tango**
LED PIR 120°
Motion Sensor Light

13  **Tango**
LED Light

15  **Tango**
PIR 120°
Motion Sensor

17  **Tango Short**
LED PIR 120°
Motion Sensor Light

19  **Tango Short**
LED Light

RUEDA

21  **Rueda**
LED PIR 120°
Motion Sensor Light

22  **Rueda**
LED Light

23  **Rueda**
PIR 120°
Motion Sensor

25  **Rueda Short**
LED PIR 120°
Motion Sensor Light

27  **Rueda Short**
LED Light

SALSA

29  **Salsa**
LED PIR 120°
Motion Sensor Light

30  **Salsa**
LED Light

31  **Salsa**
PIR 120°
Motion Sensor

32  **Salsa Short**
LED PIR 120°
Motion Sensor Light

33  **Salsa Short**
LED Light

CV Power supplies / Zasilacze napięciowe / Netzteile

34

Product index / Indeks / Index

35-38

230 V AC
10 V DC

All products in this catalogue have two power supply options: 10 V DC or 230 V AC, unless otherwise specified. SKOFF reserves the right to change the specifications without prior notice.

Wszystkie produkty w tym katalogu są zasilane na dwa sposoby: 10 V DC lub 230 V AC, chyba że podano inaczej. SKOFF zastrzega sobie prawo do zmiany specyfikacji technicznych bez wcześniejszego powiadomienia.

Die Stromversorgung aller Produkte aus diesem Katalog erfolgt auf zweierlei Art: 10 V DC oder 230 V AC, sofern nicht anders angegeben. SKOFF behält sich Änderungen in den technischen Daten ohne Ankündigung vor.

Nieskończoność rozwiązań W OŚWIETLENIU LED

Infinity of solutions IN LED LIGHTING
Unendlichkeit der Lösungen IN LED-BELEUCHTUNG



Tango

LED PIR 120° Motion Sensor Light

Tango

PIR 120° Motion Sensor

Tango

LED Light

SKOFF has expanded its offer with a range of independent sensors and sensors integrated in lighting fixtures (Sensor & Light). Considering the customers' needs, this product range is fitted with two power supply options: 10VDC and 230VAC.

SKOFF is committed to the development of lighting technology and motion sensors, focusing on the use of LED technologies, to give consumers more comfort and a better quality of life. The optimized design guarantees proper functionality and user safety in the SKOFF lighting solutions.

SKOFF poszerzył swoją ofertę o gamę samodzielnych czujników (Sensor) oraz czujników wbudowanych w oprawy oświetleniowe (Sensor & Light). Ze względu na potrzeby swoich Klientów gama tych produktów została przystosowana do zasilania na dwa sposoby: 10 V DC oraz 230 V AC.

SKOFF jest zaangażowany w rozwój oświetlenia oraz czujników ruchu, koncentrując się na wykorzystaniu technologii LED, aby zapewnić konsumentom wygodę i poprawę jakości życia. Optymalna konstrukcja zapewnia użytkownikowi funkcjonalność i bezpieczeństwo w rozwiązaniach oświetleniowych SKOFF.

SKOFF hat sein Angebot mit einem Sortiment von autonomen Sensoren (Sensor) und in die Leuchten eingebauten Sensoren (Sensor & Light) erweitert. Entsprechend dem Kundenbedarf wurde dieses Produktsortiment an Versorgung zweierlei Art angepasst: 10 V DC und 230 V AC.

SKOFF engagiert sich in die Entwicklung von Beleuchtung und Bewegungssensoren. Die Firma konzentriert sich dabei auf die Nutzung der LED-Technik, um den Komfort und die Lebensqualität der Verbraucher zu verbessern. Die optimale Konstruktion macht die Beleuchtungslösungen von SKOFF funktional und sicher für den Nutzer.

MUSIC LINE

SENSOR & LIGHT



A lot of spaces and rooms in private or public utility buildings are only used on an occasional and temporary basis (corridors, staircases, basements, utility rooms). One of the ways to control the power consumption by the lighting systems in these areas is to reduce the illumination to where it is necessary and indispensable only. Motion sensors can be helpful in this respect, as they have a direct impact on cost efficiency and improved user comfort in the building.

W budynkach prywatnych jak i użyteczności publicznej wiele przestrzeni i pomieszczeń jest używanych w sposób sporadyczny i czasowy (korytarze, klatki schodowe, piwnice, pomieszczenia techniczne). Jednym ze sposobów kontroli zużycia energii elektrycznej generowanej przez oświetlenie tych obiektów jest redukcja oświetlenia do sytuacji, w których jest ono konieczne i niezbędne. Z pomocą przychodzą czujniki ruchu, które bezpośrednio wpływają na oszczędności, a także na poprawę komfortu użytkownika obiektu.

In privaten und in öffentlichen Gebäuden wird der Raum oft sporadisch und nur vorübergehend genutzt (Flure, Treppenhäuser, Keller, technische Räume). Der Energieverbrauch bei der Beleuchtung solcher Objekte kann kontrolliert werden, z.B. indem die Beleuchtung auf die Situationen reduziert wird, in denen sie tatsächlich notwendig und erforderlich ist. Dabei sind Bewegungsmelder behilflich, die Einsparungen bringen und den Komfort bei der Nutzung eines Gebäudes erhöhen.



Czym jest TECHNOLOGIA PIR?

What is the PIR technology?
Was ist die PIR-Technologie?

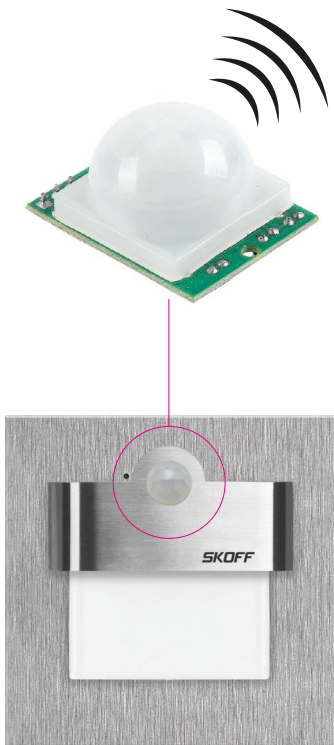

Versatile Passive Infrared. In our designs, it can be used indoors - in corridors, staircases of private multi-family buildings, where light has been left unnecessarily on for long hours after a short visit by users.

Passive infrared solutions are capable of recognizing heat radiation produced by people, converting it into electric signals. If motion is detected in the room, it will switch on the light automatically and switch it off after a certain time unless any movement is registered.

Wszecznostonna pasywna podczerwień (ang. Passive Infrared).

W naszym wykonaniu do zastosowania wewnątrz: korytarze, klatki schodowe budynków prywatnych, wielorodzinnych, czyli tam, gdzie niepotrzebnie pozostawiono oświetlenie na długie godziny po krótkotrwałej wizycie użytkowników.

Pasywna podczerwień rozpoznaje promieniowanie ciepłe wytwarzane przez ludzi i przetwarza je na sygnał elektryczny. Automatycznie załącza zasilanie oświetlenia w przypadku detekcji ruchu w pomieszczeniu i wyłącza światło po pewnym czasie, jeśli ruch nie jest rejestrowany.

Die vielseitige Passiv Infrarot Technologie (engl. Passive Infrared). In unseren Konzepten für Innenräume: Flure, Treppenhäuser in Privatgebäuden, Mehrfamilienhäusern, also überall dort, wo das Licht nach einem kurzen Besuch manchmal stundenlang noch brennt.

Das passive Infrarot erkennt die Wärmeenergie von Menschen und verwandelt sie in ein elektrisches Signal. Bei Bewegungsmeldung im Raum wird die Stromversorgung der Beleuchtung automatisch eingeschaltet und wenn keine Bewegung mehr registriert wird, wird das Licht nach einer bestimmten Zeit ausgeschaltet.

Music Line Music Line Short

Curtain or diffused?
Gerichtete Licht oder Streulicht?

This line of luminaires will give unique character to any venue - it will illuminate stairs, traffic routes, or emphasizing the interior arrangement. We present two available variants of this line: Music Line, a traditional option with a visible lighting piece, and a more subtle Music Line Short, producing the curtain light effect.

Rodzina opraw oświetleniowych nada ton każdemu pomieszczeniu, oświetlając schody, ciągi komunikacyjne lub podkreślając aranżację wnętrza. Przedstawiamy Wam do wyboru dwa warianty tej rodziny: tradycyjny z widocznym elementem świetlnym Music Line oraz subtelniejszy, dający efekt światła kurtynowego Music Line Short.

Die Produktfamilie verleiht jedem Raum die entsprechende Atmosphäre, indem sie die Treppen und Verkehrsstränge beleuchtet oder die Raumgestaltung betont. Wir präsentieren Ihnen zwei Varianten dieser Produktlinie zur Wahl: eine konventionelle mit der sichtbaren Leuchte Music Line und eine dezente, mit dem Lichtvorhang-Effekt Music Line Short.

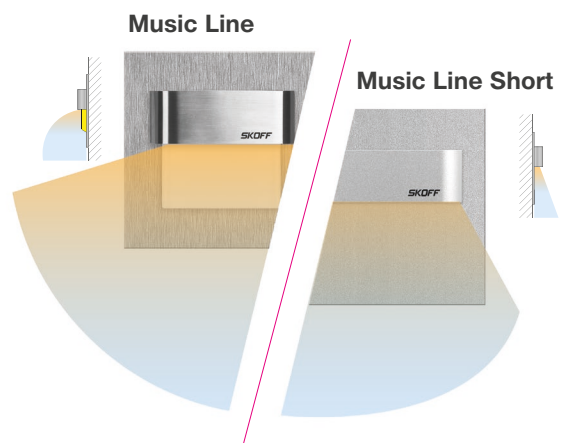

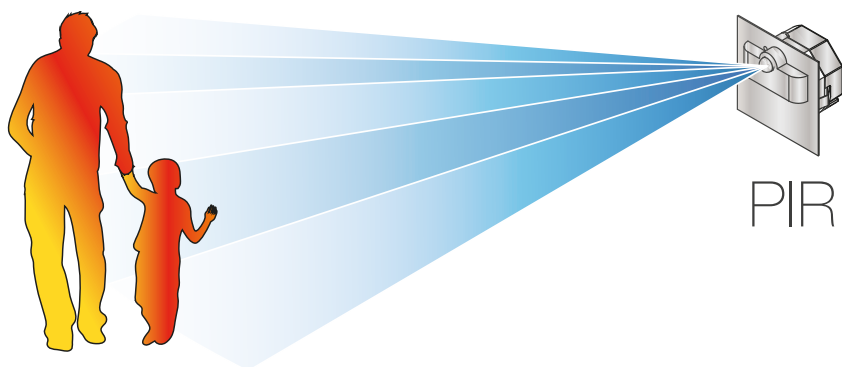

Detection

The heat produced by the body makes people or animals sources of infrared radiation. A motion sensor is fitted with an advanced optical system for proper determination of a PIR sensor viewing range. In this way, the sensor will detect every entry or exit of an object to or from the viewing range. This change of IR radiation spectrum is then analyzed and when a sufficiently high value is discovered, it will be converted into an electronic impulse, which will switch on the light.

Wykrywanie

Ciepło ciała sprawia, że ludzie czy zwierzęta jesteśmy źródłem promieniowania podczerwonego. Czujnik ruchu wyposażony jest w zaawansowany układ optyczny, pozwalający na odpowiednie uformowanie pola widzenia czujki PIR. Dzięki temu każde wejście lub wyjście obiektu z pola widzenia jest wykrywane przez sensor. Ta zmiana widma promieniowania IR jest następnie analizowana i gdy jest ona odpowiednio duża przetwarzana jest w impuls elektroniczny włączający światło.

Detektion

Durch ihre Körperwärme sind Menschen und Tiere die Quelle von Infrarotstrahlung. Der Bewegungsmelder ist mit einer hochentwickelten Optik ausgestattet, die eine entsprechende Gestaltung der Detektionszone des PIR-Sensors ermöglicht. Dadurch kann der Sensor jedes Mal „sehen“, wenn ein Objekt diese Zone betritt oder verlässt. Die Veränderung im Spektralbereich der IR-Strahlung wird anschließend analysiert. Ist sie entsprechend groß, wird sie in einen elektronischen Impuls verwandelt, der das Licht einschaltet.

Range • Zasięg • Reichweite

Depending on the specific model. Average range is defined for tangent motion (parallel to the sensor) at 3-4m (Sensor & Light) or 7-8m (Sensor).

Zasięg czujników SKOFF różni się w zależności od modelu. Przeciętny zasięg określony jest przy ruchu stycznym (równoległe do czujnika) i wynosi on 3-4 m (Sensor & Light) oraz 7-8 m (Sensor).

Je nach Modell. Die durchschnittliche Reichweite wird bei Tangentialbewegung (parallel zum Sensor) gemessen und beträgt 3-4 m (Sensor & Light) und 7-8 m (Sensor).

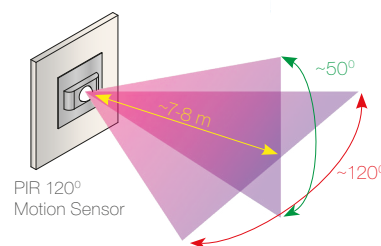
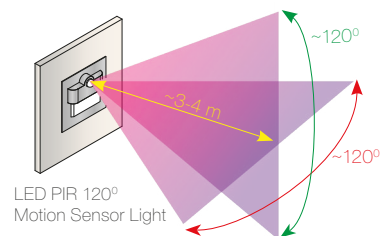

Basic settings • Ustawienia podstawowe • Grundeinstellungen



Light intensity adjustment in the range of 2 lx (night) - 200 lx.
Regulacja natężenia światła otoczenia w zakresie 2 lx (noc) - 200 lx.
Einstellung der Lichtintensität in der Umgebung im Bereich 2 lx (Nacht) - 200 lx.



Individual adjustment of light switching time 3-35 s (Sensor & Light) and 5-120 s (Sensor).
Indywidualne regulowanie czasu załączenia światła 3-35 s (Sensor & Light) oraz 5-120 s (Sensor).
Individuelle Einstellung der Lichtschaltzeit 3-35 s (Sensor & Light) und 5-120 s (Sensor).



Montaż

Installation
Montage

Wall mounting • Montaż ścienny • Wandmontage

The sensors and luminaires are fitted with integrated bracketing systems for recessed installation. The 10VDC version can be installed in a Ø 60mm opening or in a traditional junction box, after connecting power supply cables. The 230VAC version has only one mounting option, in a Ø 60mm junction box.

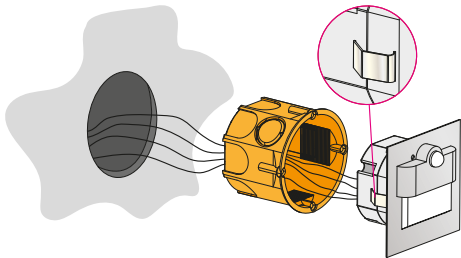

Czujniki oraz oprawy oświetleniowe mają wbudowane systemy wsporników, które umożliwiają montaż w ścianie. Wersja zasilana napięciem 10 V DC może być zamontowana zarówno w otworze Ø 60 mm jak i w tradycyjnej puszcze elektroinstalacyjnej, po uprzednim podłączeniu przewodów zasilających. Wersja zasilana napięciem 230 V AC posiada tylko jeden sposób montażu – puszka elektroinstalacyjna Ø 60 mm.

Die Sensoren und Leuchten haben eingebaute Trägersysteme für eine Wandmontage. Die Variante mit der Stromversorgung 10 V DC kann sowohl in einer Öffnung Ø 60 mm als auch in einer konventionellen Elektroinstallationsdose nach vorherigem Anschluss der Elektroleitungen montiert werden. Die Variante mit der Stromversorgung 230 V AC kann nur in einer Elektroinstallationsdose Ø 60 mm montiert werden.

Ceiling mounting • Montaż sufitowy • Deckenmontage

A motion sensor can be successfully installed in a ceiling recess. With the integrated bracketing system, mounting is possible in a traditional Ø 60mm junction box, both for the 10VDC and the 230VAC version.

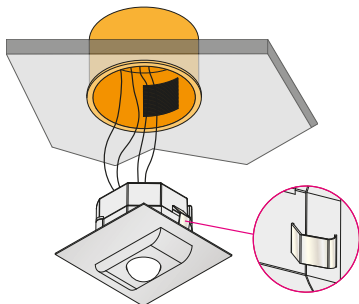

Czujnik ruchu może być z powodzeniem montowany w suficie. Wbudowany system wsporników pozwala na montaż w tradycyjnej puszcze elektroinstalacyjnej 60 mm wersji zarówno zasilanej 10 V DC jak i 230 V AC.

Der Bewegungssensor kann durchaus an der Decke montiert werden. Mithilfe der eingebauten Träger ist die Montage der beiden Varianten 10 V DC und 230 V AC in einer konventionellen Elektroinstallationsdose Ø 60 mm möglich.

Jak rozmieszczać OPRAWY LED?

Proper distribution of LED lighting fixtures ?
Verteilung der LED-Leuchten ?

Music Line

LED PIR 120° Motion Sensor

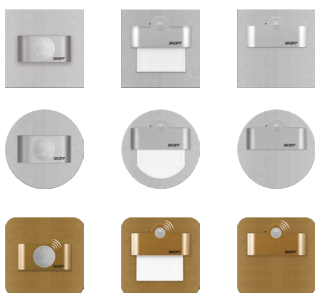

Music Line

LED Light

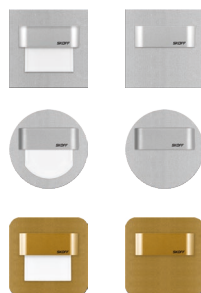

Schemat działania

Work diagram
Arbeitsanleitung

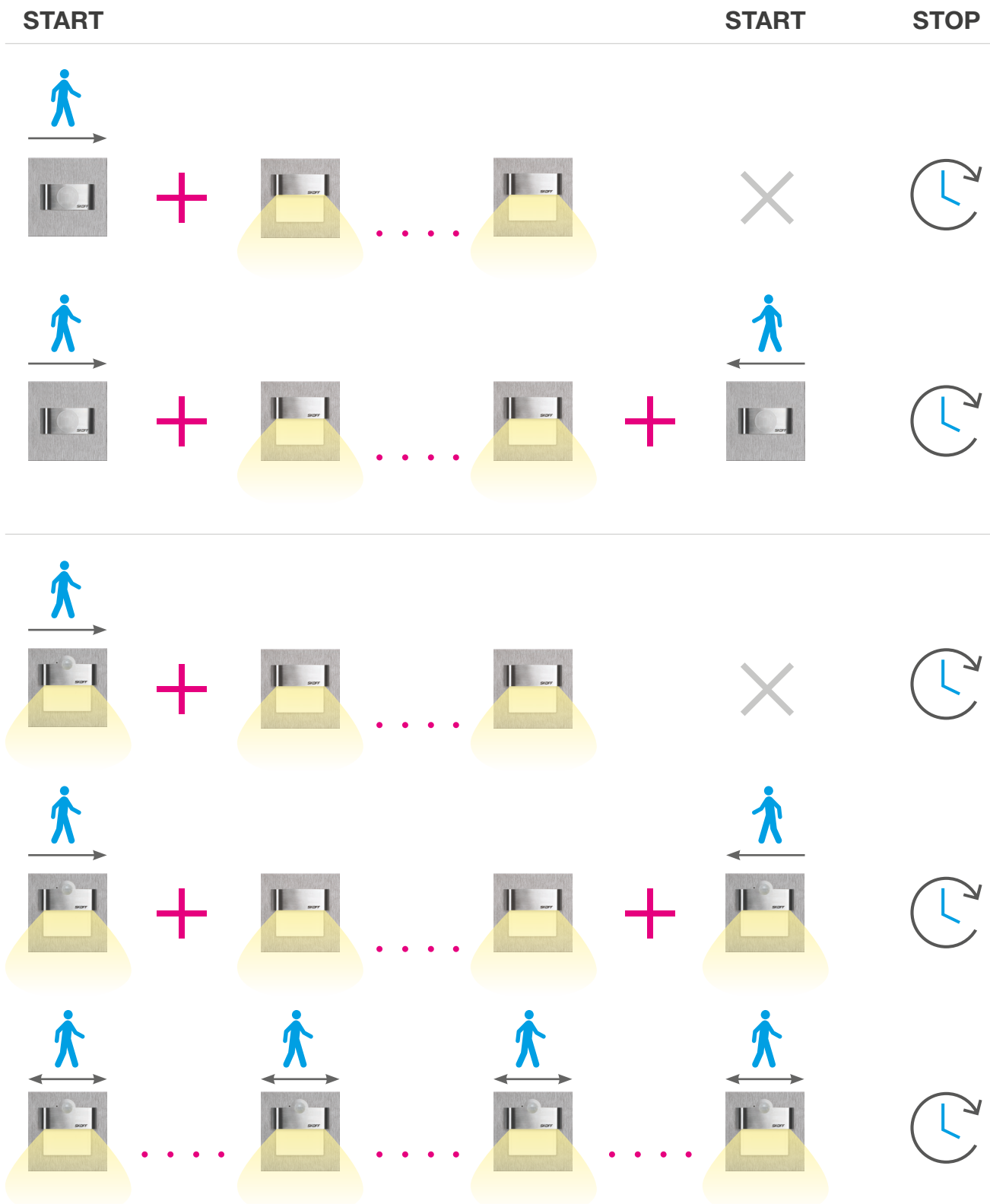

^ All 230 V AC luminaires can also be supplied with 110 V AC.
^ Wszystkie oprawy 230 V AC można również zasilac napięciem 110 V AC.
^ Alle 230 V AC-Leuchten können auch mit 110 V AC geliefert werden.

* A SKOFF ZOL power supply unit must be used for 10VDC power
* Do zasilania 10V DC konieczne jest użycie zasilacza SKOFF ZOL
* Für die Versorgung 10V DC ist das Netzteil SKOFF ZOL zu verwenden.

Power source:
Źródło prądu:
Stromquelle:





TANGO

LED PIR 120° Motion Sensor Light



- High quality LED fixture with PIR motion sensor
- An addition to the TANGO lighting line (Music Line series)
- Fit for most commercial and private circulation route illumination systems. Precision optics across 120° radius
- Integrated, adjustable dim sensor, operating range: 2-40 lx
- Metal housing (INOX)
- Choice of power supply: 230 V AC or 10 V DC
- Wysokiej jakości oprawa LED z czujnikiem ruchu PIR
- Stanowi uzupełnienie rodziny oświetlenia TANGO (seria Music Line)
- Nadaje się do większości komercyjnych i prywatnych oświetleń ciągów komunikacyjnych. Precyzyjna optyka o promieniu 120°
- Wbudowany, regulowany czujnik zmierzchu w zakresie 2-40 lx
- Obudowa metalowa (INOX)
- Zasilanie do wyboru 230 V AC lub 10 V DC
- Hochqualitative LED-Leuchte mit PIR-Bewegungssensor
- Ergänzt die Produktfamilie TANGO (Produktreihe Music Line)
- Geeignet als Beleuchtung der meisten kommerziellen und privaten Verkehrsstränge. Präzise Optik mit dem Radius 120°
- Eingebauter einstellbarer Dämmerungssensor 2-40 lx
- Metallgehäuse (INOX)
- Stromversorgung wahlweise 230 V AC oder 10 V DC



10 V DC	1,0 W	3 A	PIR 120°	Detection 3 ~ 4 m	Stand by > 0,5 W	Ra > 80	<ul style="list-style-type: none"> 6000 K 4000 K 3000 K BLUE 	IP20	III	18	73
230 V AC	2,4 W	3 A	PIR 120°	Detection 3 ~ 4 m	Stand by > 0,5 W	Ra > 80	<ul style="list-style-type: none"> 6000 K 4000 K 3000 K BLUE 	IP20		73	

Specifications tolerance ± 10% • Tolerancja parametrów technicznych ± 10% • Technische Parameter-Toleranz ± 10%



TANGO

LED Light



- High quality LED fixture
- Fit for most commercial and private circulation route illumination systems
- Metal housing (INOX)
- Very low power consumption 0,8 W
- Choice of power supply: 230 V AC or 10 V DC

- Wysokiej jakości oprawa LED
- Nadaje się do większości komercyjnych i prywatnych oświetleń ciągów komunikacyjnych
- Obudowa metalowa (INOX)
- Bardzo niski pobór prądu 0,8 W
- Zasilanie do wyboru 230 V AC lub 10 V DC

- Hochqualitative LED-Leuchte
- Geeignet als Beleuchtung der meisten kommerziellen und privaten Verkehrsstränge
- Metallgehäuse (INOX)
- Geringer Stromverbrauch 0,8 W
- Stromversorgung wahlweise 230 V AC oder 10 V DC



10 V DC	0,8 W	Ra > 80	<ul style="list-style-type: none"> ● 6000 K ● 4000 K ● 3000 K ● BLUE 	IP20 IP66	
230 V AC	1,8 W	Ra > 80	<ul style="list-style-type: none"> ● 6000 K ● 4000 K ● 3000 K ● BLUE 	IP20	

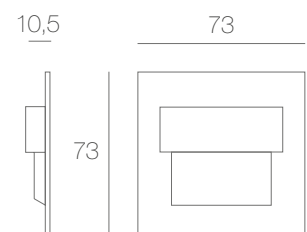

Specifications tolerance ± 10% • Tolerancja parametrów technicznych ± 10% • Technische Parameter-Toleranz ± 10%



TANGO

PIR 120° Motion Sensor



POŁĄCZ Z MUSIC LINE

Connect to MUSIC LINE
Anschluss an MUSIC LINE



- | | | |
|---|---|---|
| <ul style="list-style-type: none"> • PIR motion sensor • An addition to the TANGO lighting system (Music Line series) • Precision optics across 120° radius, offering the range of 7-8m • Integrated, adjustable dim sensor, operating range: 2-200 lx • Metal housing (INOX) • Choice of power supply: 230 V AC or 10 V DC | <ul style="list-style-type: none"> • Czujnik ruchu PIR • Stanowi uzupełnienie oświetlenia TANGO (seria Music Line) • Precyzyjna optyka o promieniu 120° oferuje zakres 7-8 m • Wbudowany, regulowany czujnik zmierzchu w zakresie 2-200 lx • Obudowa metalowa (INOX) • Zasilanie do wyboru 230 V AC lub 10 V DC | <ul style="list-style-type: none"> • PIR-Bewegungssensor • Ergänzt die Beleuchtung TANGO (Produktreihe Music Line) • Präzise Optik mit dem Radius 120° bietet die Reichweite von 7-8 m • Eingebauter einstellbarer Dämmerungssensor 2-200 lx • Metallgehäuse (INOX) • Stromversorgung wahlweise 230 V AC oder 10 V DC |
|---|---|---|

10 V DC	0,2 W	3 A	PIR 120°	Detection 7 ~ 8 m	Stand by > 0,5 W	IP20		
230 V AC	0,6 W	3 A	PIR 120°	Detection 7 ~ 8 m	Stand by > 0,5 W	IP20		

Specifications tolerance ± 10% • Tolerancja parametrów technicznych ± 10% • Technische Parameter-Toleranz ± 10%



TANGO SHORT

LED PIR 120° Motion Sensor Light



- High quality LED fixture with a concealed lighting module and a PIR motion sensor
- An addition to the TANGO SHORT lighting line (Music Line Short series)
- Fit for most commercial and private circulation route illumination systems. Precision optics across 120° radius
- Integrated, adjustable dim sensor, operating range: 2-40 lx
- Metal housing (INOX)
- Choice of power supply: 230 V AC or 10 V DC
- Wysokiej jakości oprawa LED z ukrytym modułem świetlnym oraz czujnikiem ruchu PIR
- Stanowi uzupełnienie rodziny oświetlenia TANGO SHORT (seria Music Line Short)
- Nadaje się do większości komercyjnych i prywatnych oświetleń ciągów komunikacyjnych. Precyzyjna optyka o promieniu 120°
- Wbudowany, regulowany czujnik zmierzchu w zakresie 2-40 lx
- Obudowa metalowa (INOX)
- Zasilanie do wyboru 230 V AC lub 10 V DC
- Hochqualitative LED-Leuchte mit eingebautem Lichtmodul und PIR-Bewegungssensor
- Ergänzt die Produktfamilie TANGO SHORT (Produktreihe Music Line Short)
- Geeignet als Beleuchtung der meisten kommerziellen und privaten Verkehrsstränge. Präzise Optik mit dem Radius 120°
- Eingebauter einstellbarer Dämmerungssensor 2-40 lx
- Metallgehäuse (INOX)
- Stromversorgung wahlweise 230 V AC oder 10 V DC



10 V DC	1,0 W	3 A	PIR $\nless 120^\circ$	Detection 3 ~ 4 m	Stand by > 0,5 W	Ra > 80	<ul style="list-style-type: none"> • 6000 K • 4000 K • 3000 K • BLUE 	IP20		18	
230 V AC	2,4 W	3 A	PIR $\nless 120^\circ$	Detection 3 ~ 4 m	Stand by > 0,5 W	Ra > 80	<ul style="list-style-type: none"> • 6000 K • 4000 K • 3000 K • BLUE 	IP20		73	

Specifications tolerance $\pm 10\%$ • Tolerancja parametrów technicznych $\pm 10\%$ • Technische Parameter-Toleranz $\pm 10\%$



TANGO SHORT

LED Light



- High quality LED fixture with concealed lighting module
- Curtain light effect
- Fit for most commercial and private circulation route illumination systems
- Metal housing (INOX)
- Very low power consumption 0,8 W
- Choice of power supply: 230 V AC or 10 V DC

- Wysokiej jakości oprawa LED z ukrytym modułem świetlnym
- Efekt światła kurtynowego
- Nadaje się do większości komercyjnych i prywatnych oświetleń ciągów komunikacyjnych
- Obudowa metalowa (INOX)
- Bardzo niski pobór prądu 0,8 W
- Zasilanie do wyboru 230 V AC lub 10 V DC

- Hochqualitative LED-Leuchte mit eingebautem Lichtmodul
- Lichtvorhang-Effekt
- Geeignet als Beleuchtung der meisten kommerziellen und privaten Verkehrsstränge
- Metallgehäuse (INOX)
- Geringer Stromverbrauch 0,8 W
- Stromversorgung wahlweise 230 V AC oder 10 V DC



10 V DC	0,8 W	Ra > 80	<ul style="list-style-type: none"> • 6000 K • 4000 K • 3000 K • BLUE 	IP20 IP66	
230 V AC	1,8 W	Ra > 80	<ul style="list-style-type: none"> • 6000 K • 4000 K • 3000 K • BLUE 	IP20	

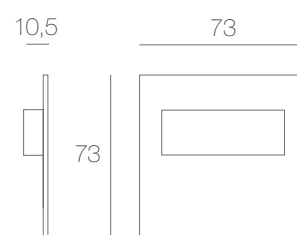

Specifications tolerance $\pm 10\%$ • Tolerancja parametrów technicznych $\pm 10\%$ • Technische Parameter-Toleranz $\pm 10\%$



RUEDA

LED PIR 120° Motion Sensor Light

K



Foto
1:1

G



D



C



- High quality LED fixture with PIR motion sensor
- An addition to the RUEDA lighting line (Music Line series)
- Fit for most commercial and private circulation route illumination systems. Precision optics across 120° radius
- Integrated, adjustable dim sensor, operating range: 2-40 lx
- Metal housing (INOX)
- Choice of power supply: 230 V AC or 10 V DC
- Wysokiej jakości oprawa LED z czujnikiem ruchu PIR
- Stanowi uzupełnienie rodziny oświetlenia RUEDA (seria Music Line)
- Nadaje się do większości komercyjnych i prywatnych oświetleń ciągów komunikacyjnych. Precyzyjna optyka o promieniu 120°
- Wbudowany, regulowany czujnik zmierzchu w zakresie 2-40 lx
- Obudowa metalowa (INOX)
- Zasilanie do wyboru 230 V AC lub 10 V DC
- Hochqualitative LED-Leuchte mit PIR-Bewegungssensor
- Ergänzt die Produktfamilie RUEDA (Produktreihe Music Line)
- Geeignet als Beleuchtung der meisten kommerziellen und privaten Verkehrsstränge. Präzise Optik mit dem Radius 120°
- Eingebauter einstellbarer Dämmerungssensor 2-40 lx
- Metallgehäuse (INOX)
- Stromversorgung wahlweise 230 V AC oder 10 V DC



10 V DC	1,0 W	3 A	PIR $\nless 120^\circ$	Detection 3 ~ 4 m	Stand by > 0,5 W	Ra > 80	<ul style="list-style-type: none"> • 6000 K • 4000 K • 3000 K • BLUE 	IP20		18	73
230 V AC	2,4 W	3 A	PIR $\nless 120^\circ$	Detection 3 ~ 4 m	Stand by > 0,5 W	Ra > 80	<ul style="list-style-type: none"> • 6000 K • 4000 K • 3000 K • BLUE 	IP20		73	

Specifications tolerance $\pm 10\%$ • Tolerancja parametrów technicznych $\pm 10\%$ • Technische Parameter-Toleranz $\pm 10\%$

RUEDA

LED Light

G



Foto 1:1

K



D



C



- High quality LED fixture
- Fit for most commercial and private circulation route illumination systems
- Metal housing (INOX)
- Very low power consumption 0,8 W
- Choice of power supply: 230 V AC or 10 V DC

- Wysokiej jakości oprawa LED
- Nadaje się do większości komercyjnych i prywatnych oświetleń ciągów komunikacyjnych
- Obudowa metalowa (INOX)
- Bardzo niski pobór prądu 0,8 W
- Zasilanie do wyboru 230 V AC lub 10 V DC

- Hochqualitative LED-Leuchte
- Geeignet als Beleuchtung der meisten kommerziellen und privaten Verkehrsstränge
- Metallgehäuse (INOX)
- Geringer Stromverbrauch 0,8 W
- Stromversorgung wahlweise 230 V AC oder 10 V DC



10 V DC	0,8 W	Ra > 80	<ul style="list-style-type: none"> • 6000 K • 4000 K • 3000 K • BLUE 	IP20 IP66	III
230 V AC	1,8 W	Ra > 80	<ul style="list-style-type: none"> • 6000 K • 4000 K • 3000 K • BLUE 	IP20	

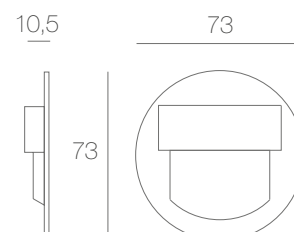

Specifications tolerance ± 10% • Tolerancja parametrów technicznych ± 10% • Technische Parameter-Toleranz ± 10%

RUEDA

PIR 120° Motion Sensor

G



Foto
1:1

K



D



C



POŁĄCZ Z MUSIC LINE

Connect with MUSIC LINE
Verbinden mit MUSIC LINE



- PIR motion sensor
- An addition to the RUEDA lighting system (Music Line series)
- Precision optics across 120° radius, offering the range of 7-8m
- Integrated, adjustable dim sensor, operating range: 2-200 lx
- Metal housing (INOX)
- Choice of power supply: 230 V AC or 10 V DC

- Czujnik ruchu PIR
- Stanowi uzupełnienie oświetlenia RUEDA (seria Music Line)
- Precyzyjna optyka o promieniu 120° oferuje zakres 7-8 m
- Wbudowany, regulowany czujnik zmierzchu w zakresie 2-200 lx
- Obudowa metalowa (INOX)
- Zasilanie do wyboru 230 V AC lub 10 V DC

- PIR-Bewegungssensor
- Ergänzt die Beleuchtung RUEDA (Produktreihe Music Line)
- Präzise Optik mit dem Radius 120° bietet die Reichweite von 7-8 m
- Eingebauter einstellbarer Dämmerungssensor 2-200 lx
- Metallgehäuse (INOX)
- Stromversorgung wahlweise 230 V AC oder 10 V DC

10 V DC	0,2 W	3 A	PIR 120°	Detection 7 ~ 8 m	Stand by > 0,5 W	IP20		CE	
230 V AC	0,6 W	3 A	PIR 120°	Detection 7 ~ 8 m	Stand by > 0,5 W	IP20			

Specifications tolerance ± 10% • Tolerancja parametrów technicznych ± 10% • Technische Parameter-Toleranz ± 10%



RUEDA SHORT

LED PIR 120° Motion Sensor Light



Foto
1:1



- High quality LED fixture with a concealed lighting module and a PIR motion sensor
- An addition to the RUEDA SHORT lighting line (Music Line Short series)
- Fit for most commercial and private circulation route illumination systems. Precision optics across 120° radius
- Integrated, adjustable dim sensor, operating range: 2-40 lx
- Metal housing (INOX)
- Choice of power supply: 230 V AC or 10 V DC
- Wysokiej jakości oprawa LED z ukrytym modułem świetlnym oraz czujnikiem ruchu PIR
- Stanowi uzupełnienie rodziny oświetlenia RUEDA SHORT (seria Music Line Short)
- Nadaje się do większości komercyjnych i prywatnych oświetleń ciągów komunikacyjnych. Precyzyjna optyka o promieniu 120°
- Wbudowany, regulowany czujnik zmierzchu w zakresie 2-40 lx
- Obudowa metalowa (INOX)
- Zasilanie do wyboru 230 V AC lub 10 V DC
- Hochqualitative LED-Leuchte mit eingebautem Lichtmodul und PIR-Bewegungssensor
- Ergänzt die Produktfamilie RUEDA SHORT (Produktreihe Music Line Short)
- Geeignet als Beleuchtung der meisten kommerziellen und privaten Verkehrsstränge. Präzise Optik mit dem Radius 120°
- Eingebauter einstellbarer Dämmerungssensor 2-40 lx
- Metallgehäuse (INOX)
- Stromversorgung wahlweise 230 V AC oder 10 V DC



10 V DC	1,0 W	3 A	PIR 120°	Detection 3 ~ 4 m	Stand by > 0,5 W	Ra > 80	<ul style="list-style-type: none"> • 6000 K • 4000 K • 3000 K • BLUE 	IP20		18	73
230 V AC	2,4 W	3 A	PIR 120°	Detection 3 ~ 4 m	Stand by > 0,5 W	Ra > 80	<ul style="list-style-type: none"> • 6000 K • 4000 K • 3000 K • BLUE 	IP20		73	

Specifications tolerance ± 10% • Tolerancja parametrów technicznych ± 10% • Technische Parameter-Toleranz ± 10%



RUEDA SHORT

LED Light



K



Foto
1:1

G



D



C



- High quality LED fixture with concealed lighting module
- Curtain light effect
- Fit for most commercial and private circulation route illumination systems
- Metal housing (INOX)
- Very low power consumption 0,8 W
- Choice of power supply: 230 V AC or 10 V DC

- Wysokiej jakości oprawa LED z ukrytym modułem świetlnym
- Efekt światła kurtynowego
- Nadaje się do większości komercyjnych i prywatnych oświetleń ciągów komunikacyjnych
- Obudowa metalowa (INOX)
- Bardzo niski pobór prądu 0,8 W
- Zasilanie do wyboru 230 V AC lub 10 V DC

- Hochqualitative LED-Leuchte mit eingebautem Lichtmodul
- Lichtvorhang-Effekt
- Geeignet als Beleuchtung der meisten kommerziellen und privaten Verkehrsstränge
- Metallgehäuse (INOX)
- Geringer Stromverbrauch 0,8 W
- Stromversorgung wahlweise 230 V AC oder 10 V DC



10 V DC	0,8 W	Ra > 80	<ul style="list-style-type: none"> • 6000 K • 4000 K • 3000 K • BLUE 	IP20 IP66	
230 V AC	1,8 W	Ra > 80	<ul style="list-style-type: none"> • 6000 K • 4000 K • 3000 K • BLUE 	IP20	

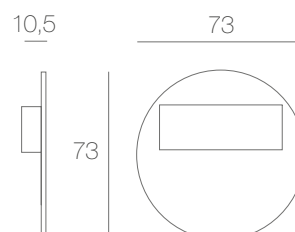

Specifications tolerance ± 10% • Tolerancja parametrów technicznych ± 10% • Technische Parameter-Toleranz ± 10%



SALSA

LED PIR 120° Motion Sensor Light



Foto
1:1

- High quality LED fixture with PIR motion sensor
- An addition to the SALSA lighting line (Music Line series)
- Fit for most commercial and private circulation route illumination systems. Precision optics across 120° radius
- Integrated, adjustable dim sensor, operating range: 2-40 lx
- Metal housing (INOX)
- Choice of power supply: 230 V AC or 10 V DC
- Wysokiej jakości oprawa LED z czujnikiem ruchu PIR
- Stanowi uzupełnienie rodziny oświetlenia SALSA (seria Music Line)
- Nadaje się do większości komercyjnych i prywatnych oświetleń ciągów komunikacyjnych. Precyzyjna optyka o promieniu 120°
- Wbudowany, regulowany czujnik zmierzchu w zakresie 2-40 lx
- Obudowa metalowa (INOX)
- Zasilanie do wyboru 230 V AC lub 10 V DC
- Hochqualitative LED-Leuchte mit PIR-Bewegungssensor
- Ergänzt die Produktfamilie SALSA (Produktreihe Music Line)
- Geeignet als Beleuchtung der meisten kommerziellen und privaten Verkehrsstränge. Präzise Optik mit dem Radius 120°
- Eingebauter einstellbarer Dämmerungssensor 2-40 lx
- Metallgehäuse (INOX)
- Stromversorgung wahlweise 230 V AC oder 10 V DC



10 V DC	1,0 W	3 A	PIR* 120°	Detection 3 ~ 4 m	Stand by > 0,5 W	Ra > 80	● 4000 K ● 3000 K	IP20	III
230 V AC	2,4 W	3 A	PIR* 120°	Detection 3 ~ 4 m	Stand by > 0,5 W	Ra > 80	● 4000 K ● 3000 K	IP20	□

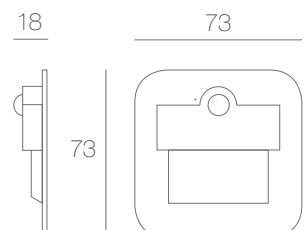

Specifications tolerance ± 10% • Tolerancja parametrów technicznych ± 10% • Technische Parameter-Toleranz ± 10%

RUEDA

LED Light



- High quality LED fixture
- Fit for most commercial and private circulation route illumination systems
- Metal housing (INOX)
- Very low power consumption 0,8 W
- Choice of power supply: 230 V AC or 10 V DC
- Wysokiej jakości oprawa LED
- Nadaje się do większości komercyjnych i prywatnych oświetleń ciągów komunikacyjnych
- Obudowa metalowa (INOX)
- Bardzo niski pobór prądu 0,8 W
- Zasilanie do wyboru 230 V AC lub 10 V DC
- Hochqualitative LED-Leuchte
- Geeignet als Beleuchtung der meisten kommerziellen und privaten Verkehrsstränge
- Metallgehäuse (INOX)
- Geringer Stromverbrauch 0,8 W
- Stromversorgung wahlweise 230 V AC oder 10 V DC



10 V DC	0,8 W	Ra > 80	● 4000 K ● 3000 K	IP20 IP66	III
230 V AC	1,8 W	Ra > 80	● 4000 K ● 3000 K	IP20	□

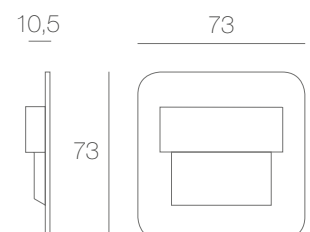

Specifications tolerance $\pm 10\%$ • Tolerancja parametrów technicznych $\pm 10\%$ • Technische Parameter-Toleranz $\pm 10\%$

RUEDA

PIR 120° Motion Sensor



M



Foto
1:1

POŁĄCZ Z MUSIC LINE

Connect with MUSIC LINE
Verbinden mit MUSIC LINE



- PIR motion sensor
- An addition to the SALSA lighting system (Music Line series)
- Precision optics across 120° radius, offering the range of 7-8m
- Integrated, adjustable dim sensor, operating range: 2-200 lx
- Metal housing (INOX)
- Choice of power supply: 230 V AC or 10 V DC

- Czujnik ruchu PIR
- Stanowi uzupełnienie oświetlenia SALSA (seria Music Line)
- Precyzyjna optyka o promieniu 120° oferuje zakres 7-8 m
- Wbudowany, regulowany czujnik zmierzchu w zakresie 2-200 lx
- Obudowa metalowa (INOX)
- Zasilanie do wyboru 230 V AC lub 10 V DC

- PIR-Bewegungssensor
- Ergänzt die Beleuchtung SALSA (Produktreihe Music Line)
- Präzise Optik mit dem Radius 120° bietet die Reichweite von 7-8 m
- Eingebauter einstellbarer Dämmerungssensor 2-200 lx
- Metallgehäuse (INOX)
- Stromversorgung wahlweise 230 V AC oder 10 V DC

10 V DC	0,2 W	3 A	PIR 120°	Detection 7 ~ 8 m	Stand by > 0,5 W	IP20		CE	
230 V AC	0,6 W	3 A	PIR 120°	Detection 7 ~ 8 m	Stand by > 0,5 W	IP20			

Specifications tolerance ± 10% • Tolerancja parametrów technicznych ± 10% • Technische Parameter-Toleranz ± 10%

SALSA SHORT

PIR 120° Motion Sensor Light



- High quality LED fixture with a concealed lighting module and a PIR motion sensor
- An addition to the SALSA SHORT lighting line (Music Line Short series)
- Fit for most commercial and private circulation route illumination systems. Precision optics across 120° radius
- Integrated, adjustable dim sensor, operating range: 2-40 lx
- Metal housing (INOX)
- Choice of power supply: 230 V AC or 10 V DC
- Wysokiej jakości oprawa LED z ukrytym modułem świetlnym oraz czujnikiem ruchu PIR
- Stanowi uzupełnienie rodziny oświetlenia SALSA SHORT (seria Music Line Short)
- Nadaje się do większości komercyjnych i prywatnych oświetleń ciągów komunikacyjnych. Precyzyjna optyka o promieniu 120°
- Wbudowany, regulowany czujnik zmierzchu w zakresie 2-40 lx
- Obudowa metalowa (INOX)
- Zasilanie do wyboru 230 V AC lub 10 V DC
- Hochqualitative LED-Leuchte mit eingebautem Lichtmodul und PIR-Bewegungssensor
- Ergänzt die Produktfamilie SALSA SHORT (Produktreihe Music Line Short)
- Geeignet als Beleuchtung der meisten kommerziellen und privaten Verkehrsstränge. Präzise Optik mit dem Radius 120°
- Eingebauter einstellbarer Dämmerungssensor 2-40 lx
- Metallgehäuse (INOX)
- Stromversorgung wahlweise 230 V AC oder 10 V DC



10 V DC	1,0 W	3 A	PIR ∇ 120°	Detection 3 ~ 4 m	Stand by > 0,5 W	Ra > 80	● 4000 K ● 3000 K	IP20	III
230 V AC	2,4 W	3 A	PIR ∇ 120°	Detection 3 ~ 4 m	Stand by > 0,5 W	Ra > 80	● 4000 K ● 3000 K	IP20	□

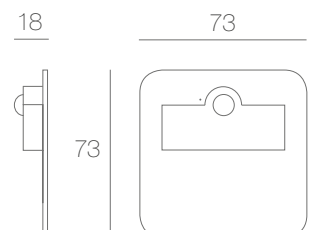

Specifications tolerance $\pm 10\%$ • Tolerancja parametrów technicznych $\pm 10\%$ • Technische Parameter-Toleranz $\pm 10\%$

SALSA SHORT

LED Light



M



Foto
1:1

- High quality LED fixture with concealed lighting module
- Curtain light effect
- Fit for most commercial and private circulation route illumination systems
- Metal housing (INOX)
- Very low power consumption 0,8 W
- Choice of power supply: 230 V AC or 10 V DC
- Wysokiej jakości oprawa LED z ukrytym modułem świetlnym
- Efekt światła kurtynowego
- Nadaje się do większości komercyjnych i prywatnych oświetleń ciągów komunikacyjnych
- Obudowa metalowa (INOX)
- Bardzo niski pobór prądu 0,8 W
- Zasilanie do wyboru 230 V AC lub 10 V DC
- Hochqualitative LED-Leuchte mit eingebautem Lichtmodul
- Lichtvorhang-Effekt
- Geeignet als Beleuchtung der meisten kommerziellen und privaten Verkehrsstränge
- Metallgehäuse (INOX)
- Geringer Stromverbrauch 0,8 W
- Stromversorgung wahlweise 230 V AC oder 10 V DC



10 V DC	0,8 W	Ra > 80	● 4000 K ● 3000 K	IP20 IP66	
230 V AC	1,8 W	Ra > 80	● 4000 K ● 3000 K	IP20	

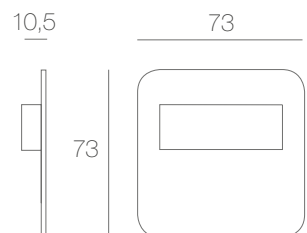

Specifications tolerance ± 10% • Tolerancja parametrów technicznych ± 10% • Technische Parameter-Toleranz ± 10%

ZOL 7-10

7 W	10 V DC	0,7 A	50 Hz	100 - 240 V AC
IP20				



ZOL 15-10

15 W	10 V DC	1,5 A	50 Hz	100 - 240 V AC
IP20				



ZOL 6

6 W	10 V DC	0,6 A	50 Hz	100 - 240 V AC
IP68				



ZOL 16

16 W	10 V DC	1,6 A	50 Hz	100 - 240 V AC
IP68				



ZOL 19-10

19 W	10 V DC	1,9 A	50 Hz	100 - 240 V AC
IP68				



SKOFF's innovative pulsed power supplies provide direct current voltage (10 V DC) to other circuits and electronic (electric) devices. They are compact sized and lightweight. Some will fit into traditional electrical junction boxes. Ideal for supplying power to the Music Line luminaires.

Innowacyjne zasilacze impulsowe marki SKOFF służą do zasilania napięciem stałym (10 V DC) obwodów i urządzeń elektronicznych (elektrycznych). Charakteryzują się małymi gabarytami i niewielką wagą. Niektóre z nich swym kształtem pasują do tradycyjnych puszek elektroinstalacyjnych. Idealnie nadają się do zasilania opraw serii Music Line.

Innovative Schaltnetzteile von SKOFF versorgen mit Gleichspannung (10 V DC) sonstige elektronische (elektrische) Schaltungen und Geräte. Sie sind klein und leicht. Einige Formen passen auch in die üblichen Elektroinstallationsdosen. Sie eignen sich ideal zur Versorgung der Music Line-Leuchten.

PUSZKA ELEKTROINSTALACYJNA Ø60



Junction box P60
Puszka elektr-inst. P60
Einbaudose P60
Ø60 x 40 mm

Index

Page	Description	Voltage	Finishing	Colour Temperature	Protection class	Index
11	Tango LED PIR 120 Motion Sensor Light	10 V DC	stainless steel	6000 K	IP 20	MJ-TAN-K-W
11	Tango LED PIR 120 Motion Sensor Light	10 V DC	stainless steel	4000 K	IP 20	MJ-TAN-K-N
11	Tango LED PIR 120 Motion Sensor Light	10 V DC	stainless steel	3000 K	IP 20	MJ-TAN-K-H
11	Tango LED PIR 120 Motion Sensor Light	10 V DC	stainless steel	blue	IP 20	MJ-TAN-K-B
11	Tango LED PIR 120 Motion Sensor Light	10 V DC	aluminium	6000 K	IP 20	MJ-TAN-G-W
11	Tango LED PIR 120 Motion Sensor Light	10 V DC	aluminium	4000 K	IP 20	MJ-TAN-G-N
11	Tango LED PIR 120 Motion Sensor Light	10 V DC	aluminium	3000 K	IP 20	MJ-TAN-G-H
11	Tango LED PIR 120 Motion Sensor Light	10 V DC	aluminium	blue	IP 20	MJ-TAN-G-B
11	Tango LED PIR 120 Motion Sensor Light	10 V DC	black	6000 K	IP 20	MJ-TAN-D-W
11	Tango LED PIR 120 Motion Sensor Light	10 V DC	black	4000 K	IP 20	MJ-TAN-D-N
11	Tango LED PIR 120 Motion Sensor Light	10 V DC	black	3000 K	IP 20	MJ-TAN-D-H
11	Tango LED PIR 120 Motion Sensor Light	10 V DC	black	blue	IP 20	MJ-TAN-D-B
11	Tango LED PIR 120 Motion Sensor Light	10 V DC	white	6000 K	IP 20	MJ-TAN-C-W
11	Tango LED PIR 120 Motion Sensor Light	10 V DC	white	4000 K	IP 20	MJ-TAN-C-N
11	Tango LED PIR 120 Motion Sensor Light	10 V DC	white	3000 K	IP 20	MJ-TAN-C-H
11	Tango LED PIR 120 Motion Sensor Light	10 V DC	white	blue	IP 20	MJ-TAN-C-B
11	Tango LED PIR 120 Motion Sensor Light	230 V AC	stainless steel	6000 K	IP 20	MM-TAN-K-W
11	Tango LED PIR 120 Motion Sensor Light	230 V AC	stainless steel	4000 K	IP 20	MM-TAN-K-N
11	Tango LED PIR 120 Motion Sensor Light	230 V AC	stainless steel	3000 K	IP 20	MM-TAN-K-H
11	Tango LED PIR 120 Motion Sensor Light	230 V AC	stainless steel	blue	IP 20	MM-TAN-K-B
11	Tango LED PIR 120 Motion Sensor Light	230 V AC	aluminium	6000 K	IP 20	MM-TAN-G-W
11	Tango LED PIR 120 Motion Sensor Light	230 V AC	aluminium	4000 K	IP 20	MM-TAN-G-N
11	Tango LED PIR 120 Motion Sensor Light	230 V AC	aluminium	3000 K	IP 20	MM-TAN-G-H
11	Tango LED PIR 120 Motion Sensor Light	230 V AC	aluminium	blue	IP 20	MM-TAN-G-B
11	Tango LED PIR 120 Motion Sensor Light	230 V AC	black	6000 K	IP 20	MM-TAN-D-W
11	Tango LED PIR 120 Motion Sensor Light	230 V AC	black	4000 K	IP 20	MM-TAN-D-N
11	Tango LED PIR 120 Motion Sensor Light	230 V AC	black	3000 K	IP 20	MM-TAN-D-H
11	Tango LED PIR 120 Motion Sensor Light	230 V AC	black	blue	IP 20	MM-TAN-D-B
11	Tango LED PIR 120 Motion Sensor Light	230 V AC	white	6000 K	IP 20	MM-TAN-C-W
11	Tango LED PIR 120 Motion Sensor Light	230 V AC	white	4000 K	IP 20	MM-TAN-C-N
11	Tango LED PIR 120 Motion Sensor Light	230 V AC	white	3000 K	IP 20	MM-TAN-C-H
11	Tango LED PIR 120 Motion Sensor Light	230 V AC	white	blue	IP 20	MM-TAN-C-B
13	Tango LED Light	10 V DC	stainless steel	6000 K	IP 20	ML-TAN-K-W
13	Tango LED Light	10 V DC	stainless steel	4000 K	IP 20	ML-TAN-K-N
13	Tango LED Light	10 V DC	stainless steel	3000 K	IP 20	ML-TAN-K-H
13	Tango LED Light	10 V DC	stainless steel	blue	IP 20	ML-TAN-K-B
13	Tango LED Light	10 V DC	aluminium	6000 K	IP 20	ML-TAN-G-W
13	Tango LED Light	10 V DC	aluminium	4000 K	IP 20	ML-TAN-G-N
13	Tango LED Light	10 V DC	aluminium	3000 K	IP 20	ML-TAN-G-H
13	Tango LED Light	10 V DC	aluminium	blue	IP 20	ML-TAN-G-B
13	Tango LED Light	10 V DC	black	6000 K	IP 20	ML-TAN-D-W
13	Tango LED Light	10 V DC	black	4000 K	IP 20	ML-TAN-D-N
13	Tango LED Light	10 V DC	black	3000 K	IP 20	ML-TAN-D-H
13	Tango LED Light	10 V DC	black	blue	IP 20	ML-TAN-D-B
13	Tango LED Light	10 V DC	white	6000 K	IP 20	ML-TAN-C-W
13	Tango LED Light	10 V DC	white	4000 K	IP 20	ML-TAN-C-N
13	Tango LED Light	10 V DC	white	3000 K	IP 20	ML-TAN-C-H
13	Tango LED Light	10 V DC	white	blue	IP 20	ML-TAN-C-B
13	Tango LED Light	10 V DC	stainless steel	6000 K	IP 66	MH-TAN-K-W
13	Tango LED Light	10 V DC	stainless steel	4000 K	IP 66	MH-TAN-K-N
13	Tango LED Light	10 V DC	stainless steel	3000 K	IP 66	MH-TAN-K-H
13	Tango LED Light	10 V DC	stainless steel	blue	IP 66	MH-TAN-K-B
13	Tango LED Light	10 V DC	aluminium	6000 K	IP 66	MH-TAN-G-W
13	Tango LED Light	10 V DC	aluminium	4000 K	IP 66	MH-TAN-G-N
13	Tango LED Light	10 V DC	aluminium	3000 K	IP 66	MH-TAN-G-H
13	Tango LED Light	10 V DC	aluminium	blue	IP 66	MH-TAN-G-B
13	Tango LED Light	10 V DC	black	6000 K	IP 66	MH-TAN-D-W
13	Tango LED Light	10 V DC	black	4000 K	IP 66	MH-TAN-D-N
13	Tango LED Light	10 V DC	black	3000 K	IP 66	MH-TAN-D-H
13	Tango LED Light	10 V DC	black	blue	IP 66	MH-TAN-D-B
13	Tango LED Light	10 V DC	white	6000 K	IP 66	MH-TAN-C-W
13	Tango LED Light	10 V DC	white	4000 K	IP 66	MH-TAN-C-N
13	Tango LED Light	10 V DC	white	3000 K	IP 66	MH-TAN-C-H
13	Tango LED Light	10 V DC	white	blue	IP 66	MH-TAN-C-B
13	Tango LED Light	230 V AC	stainless steel	6000 K	IP 20	MA-TAN-K-W
13	Tango LED Light	230 V AC	stainless steel	4000 K	IP 20	MA-TAN-K-N
13	Tango LED Light	230 V AC	stainless steel	3000 K	IP 20	MA-TAN-K-H
13	Tango LED Light	230 V AC	stainless steel	blue	IP 20	MA-TAN-K-B
13	Tango LED Light	230 V AC	aluminium	6000 K	IP 20	MA-TAN-G-W
13	Tango LED Light	230 V AC	aluminium	4000 K	IP 20	MA-TAN-G-N
13	Tango LED Light	230 V AC	aluminium	3000 K	IP 20	MA-TAN-G-H
13	Tango LED Light	230 V AC	aluminium	blue	IP 20	MA-TAN-G-B
13	Tango LED Light	230 V AC	black	6000 K	IP 20	MA-TAN-D-W
13	Tango LED Light	230 V AC	black	4000 K	IP 20	MA-TAN-D-N
13	Tango LED Light	230 V AC	black	3000 K	IP 20	MA-TAN-D-H
13	Tango LED Light	230 V AC	black	blue	IP 20	MA-TAN-D-B
13	Tango LED Light	230 V AC	white	6000 K	IP 20	MA-TAN-C-W
13	Tango LED Light	230 V AC	white	4000 K	IP 20	MA-TAN-C-N
13	Tango LED Light	230 V AC	white	3000 K	IP 20	MA-TAN-C-H
13	Tango LED Light	230 V AC	white	blue	IP 20	MA-TAN-C-B
15	Tango PIR 120 Motion Sensor	10 V DC	stainless steel		IP 20	MC-TAN-K-0
15	Tango PIR 120 Motion Sensor	10 V DC	aluminium		IP 20	MC-TAN-G-0
15	Tango PIR 120 Motion Sensor	10 V DC	black		IP 20	MC-TAN-D-0
15	Tango PIR 120 Motion Sensor	10 V DC	white		IP 20	MC-TAN-C-0
15	Tango PIR 120 Motion Sensor	230 V AC	stainless steel		IP 20	MD-TAN-K-0
15	Tango PIR 120 Motion Sensor	230 V AC	aluminium		IP 20	MD-TAN-G-0
15	Tango PIR 120 Motion Sensor	230 V AC	black		IP 20	MD-TAN-D-0

Page	Description	Voltage	Finishing	Colour Temperature	Protection class	Index
15	Tango PIR 120 Motion Sensor	230 V AC	white		IP 20	MD-TAN-C-0
17	Tango Short LED PIR 120 Motion Sensor Light	10 V DC	stainless steel	6000 K	IP 20	MK-TAN-K-W
17	Tango Short LED PIR 120 Motion Sensor Light	10 V DC	stainless steel	4000 K	IP 20	MK-TAN-K-N
17	Tango Short LED PIR 120 Motion Sensor Light	10 V DC	stainless steel	3000 K	IP 20	MK-TAN-K-H
17	Tango Short LED PIR 120 Motion Sensor Light	10 V DC	stainless steel	blue	IP 20	MK-TAN-K-B
17	Tango Short LED PIR 120 Motion Sensor Light	10 V DC	aluminium	6000 K	IP 20	MK-TAN-G-W
17	Tango Short LED PIR 120 Motion Sensor Light	10 V DC	aluminium	4000 K	IP 20	MK-TAN-G-N
17	Tango Short LED PIR 120 Motion Sensor Light	10 V DC	aluminium	3000 K	IP 20	MK-TAN-G-H
17	Tango Short LED PIR 120 Motion Sensor Light	10 V DC	aluminium	blue	IP 20	MK-TAN-G-B
17	Tango Short LED PIR 120 Motion Sensor Light	10 V DC	black	6000 K	IP 20	MK-TAN-D-W
17	Tango Short LED PIR 120 Motion Sensor Light	10 V DC	black	4000 K	IP 20	MK-TAN-D-N
17	Tango Short LED PIR 120 Motion Sensor Light	10 V DC	black	3000 K	IP 20	MK-TAN-D-H
17	Tango Short LED PIR 120 Motion Sensor Light	10 V DC	black	blue	IP 20	MK-TAN-D-B
17	Tango Short LED PIR 120 Motion Sensor Light	10 V DC	white	6000 K	IP 20	MK-TAN-C-W
17	Tango Short LED PIR 120 Motion Sensor Light	10 V DC	white	4000 K	IP 20	MK-TAN-C-N
17	Tango Short LED PIR 120 Motion Sensor Light	10 V DC	white	3000 K	IP 20	MK-TAN-C-H
17	Tango Short LED PIR 120 Motion Sensor Light	10 V DC	white	blue	IP 20	MK-TAN-C-B
17	Tango Short LED PIR 120 Motion Sensor Light	230 V AC	stainless steel	6000 K	IP 20	MN-TAN-K-W
17	Tango Short LED PIR 120 Motion Sensor Light	230 V AC	stainless steel	4000 K	IP 20	MN-TAN-K-N
17	Tango Short LED PIR 120 Motion Sensor Light	230 V AC	stainless steel	3000 K	IP 20	MN-TAN-K-H
17	Tango Short LED PIR 120 Motion Sensor Light	230 V AC	stainless steel	blue	IP 20	MN-TAN-K-B
17	Tango Short LED PIR 120 Motion Sensor Light	230 V AC	aluminium	6000 K	IP 20	MN-TAN-G-W
17	Tango Short LED PIR 120 Motion Sensor Light	230 V AC	aluminium	4000 K	IP 20	MN-TAN-G-N
17	Tango Short LED PIR 120 Motion Sensor Light	230 V AC	aluminium	3000 K	IP 20	MN-TAN-G-H
17	Tango Short LED PIR 120 Motion Sensor Light	230 V AC	aluminium	blue	IP 20	MN-TAN-G-B
17	Tango Short LED PIR 120 Motion Sensor Light	230 V AC	black	6000 K	IP 20	MN-TAN-D-W
17	Tango Short LED PIR 120 Motion Sensor Light	230 V AC	black	4000 K	IP 20	MN-TAN-D-N
17	Tango Short LED PIR 120 Motion Sensor Light	230 V AC	black	3000 K	IP 20	MN-TAN-D-H
17	Tango Short LED PIR 120 Motion Sensor Light	230 V AC	black	blue	IP 20	MN-TAN-D-B
17	Tango Short LED PIR 120 Motion Sensor Light	230 V AC	white	6000 K	IP 20	MN-TAN-C-W
17	Tango Short LED PIR 120 Motion Sensor Light	230 V AC	white	4000 K	IP 20	MN-TAN-C-N
17	Tango Short LED PIR 120 Motion Sensor Light	230 V AC	white	3000 K	IP 20	MN-TAN-C-H
17	Tango Short LED PIR 120 Motion Sensor Light	230 V AC	white	blue	IP 20	MN-TAN-C-B
19	Tango Short LED Light	10 V DC	stainless steel	6000 K	IP 20	MI-TAN-K-W
19	Tango Short LED Light	10 V DC	stainless steel	4000 K	IP 20	MI-TAN-K-N
19	Tango Short LED Light	10 V DC	stainless steel	3000 K	IP 20	MI-TAN-K-H
19	Tango Short LED Light	10 V DC	stainless steel	blue	IP 20	MI-TAN-K-B
19	Tango Short LED Light	10 V DC	aluminium	6000 K	IP 20	MI-TAN-G-W
19	Tango Short LED Light	10 V DC	aluminium	4000 K	IP 20	MI-TAN-G-N
19	Tango Short LED Light	10 V DC	aluminium	3000 K	IP 20	MI-TAN-G-H
19	Tango Short LED Light	10 V DC	aluminium	blue	IP 20	MI-TAN-G-B
19	Tango Short LED Light	10 V DC	black	6000 K	IP 20	MI-TAN-D-W
19	Tango Short LED Light	10 V DC	black	4000 K	IP 20	MI-TAN-D-N
19	Tango Short LED Light	10 V DC	black	3000 K	IP 20	MI-TAN-D-H
19	Tango Short LED Light	10 V DC	black	blue	IP 20	MI-TAN-D-B
19	Tango Short LED Light	10 V DC	white	6000 K	IP 20	MI-TAN-C-W
19	Tango Short LED Light	10 V DC	white	4000 K	IP 20	MI-TAN-C-N
19	Tango Short LED Light	10 V DC	white	3000 K	IP 20	MI-TAN-C-H
19	Tango Short LED Light	10 V DC	white	blue	IP 20	MI-TAN-C-B
19	Tango Short LED Light	10 V DC	stainless steel	6000 K	IP 66	MS-TAN-K-W
19	Tango Short LED Light	10 V DC	stainless steel	4000 K	IP 66	MS-TAN-K-N
19	Tango Short LED Light	10 V DC	stainless steel	3000 K	IP 66	MS-TAN-K-H
19	Tango Short LED Light	10 V DC	stainless steel	blue	IP 66	MS-TAN-K-B
19	Tango Short LED Light	10 V DC	aluminium	6000 K	IP 66	MS-TAN-G-W
19	Tango Short LED Light	10 V DC	aluminium	4000 K	IP 66	MS-TAN-G-N
19	Tango Short LED Light	10 V DC	aluminium	3000 K	IP 66	MS-TAN-G-H
19	Tango Short LED Light	10 V DC	aluminium	blue	IP 66	MS-TAN-G-B
19	Tango Short LED Light	10 V DC	black	6000 K	IP 66	MS-TAN-D-W
19	Tango Short LED Light	10 V DC	black	4000 K	IP 66	MS-TAN-D-N
19	Tango Short LED Light	10 V DC	black	3000 K	IP 66	MS-TAN-D-H
19	Tango Short LED Light	10 V DC	black	blue	IP 66	MS-TAN-D-B
19	Tango Short LED Light	10 V DC	white	6000 K	IP 66	MS-TAN-C-W
19	Tango Short LED Light	10 V DC	white	4000 K	IP 66	MS-TAN-C-N
19	Tango Short LED Light	10 V DC	white	3000 K	IP 66	MS-TAN-C-H
19	Tango Short LED Light	10 V DC	white	blue	IP 66	MS-TAN-C-B
19	Tango Short LED Light	230 V AC	stainless steel	6000 K	IP 20	MB-TAN-K-W
19	Tango Short LED Light	230 V AC	stainless steel	4000 K	IP 20	MB-TAN-K-N
19	Tango Short LED Light	230 V AC	stainless steel	3000 K	IP 20	MB-TAN-K-H
19	Tango Short LED Light	230 V AC	stainless steel	blue	IP 20	MB-TAN-K-B
19	Tango Short LED Light	230 V AC	aluminium	6000 K	IP 20	MB-TAN-G-W
19	Tango Short LED Light	230 V AC	aluminium	4000 K	IP 20	MB-TAN-G-N
19	Tango Short LED Light	230 V AC	aluminium	3000 K	IP 20	MB-TAN-G-H
19	Tango Short LED Light	230 V AC	aluminium	blue	IP 20	MB-TAN-G-B
19	Tango Short LED Light	230 V AC	black	6000 K	IP 20	MB-TAN-D-W
19	Tango Short LED Light	230 V AC	black	4000 K	IP 20	MB-TAN-D-N
19	Tango Short LED Light	230 V AC	black	3000 K	IP 20	MB-TAN-D-H
19	Tango Short LED Light	230 V AC	black	blue	IP 20	MB-TAN-D-B
19	Tango Short LED Light	230 V AC	white	6000 K	IP 20	MB-TAN-C-W
19	Tango Short LED Light	230 V AC	white	4000 K	IP 20	MB-TAN-C-N
19	Tango Short LED Light	230 V AC	white	3000 K	IP 20	MB-TAN-C-H
19	Tango Short LED Light	230 V AC	white	blue	IP 20	MB-TAN-C-B
21	Rueda LED PIR 120 Motion Sensor Light	10 V DC	stainless steel	6000 K	IP 20	MJ-RUE-K-W
21	Rueda LED PIR 120 Motion Sensor Light	10 V DC	stainless steel	4000 K	IP 20	MJ-RUE-K-N
21	Rueda LED PIR 120 Motion Sensor Light	10 V DC	stainless steel	3000 K	IP 20	MJ-RUE-K-H
21	Rueda LED PIR 120 Motion Sensor Light	10 V DC	stainless steel	blue	IP 20	MJ-RUE-K-B
21	Rueda LED PIR 120 Motion Sensor Light	10 V DC	aluminium	6000 K	IP 20	MJ-RUE-G-W
21	Rueda LED PIR 120 Motion Sensor Light	10 V DC	aluminium	4000 K	IP 20	MJ-RUE-G-N

Page	Description	Voltage	Finishing	Colour Temperature	Protection class	Index
21	Rueda LED PIR 120 Motion Sensor Light	10 V DC	aluminium	3000 K	IP 20	MJ-RUE-G-H
21	Rueda LED PIR 120 Motion Sensor Light	10 V DC	aluminium	blue	IP 20	MJ-RUE-G-B
21	Rueda LED PIR 120 Motion Sensor Light	10 V DC	black	6000 K	IP 20	MJ-RUE-D-W
21	Rueda LED PIR 120 Motion Sensor Light	10 V DC	black	4000 K	IP 20	MJ-RUE-D-N
21	Rueda LED PIR 120 Motion Sensor Light	10 V DC	black	3000 K	IP 20	MJ-RUE-D-H
21	Rueda LED PIR 120 Motion Sensor Light	10 V DC	black	blue	IP 20	MJ-RUE-D-B
21	Rueda LED PIR 120 Motion Sensor Light	10 V DC	white	6000 K	IP 20	MJ-RUE-C-W
21	Rueda LED PIR 120 Motion Sensor Light	10 V DC	white	4000 K	IP 20	MJ-RUE-C-N
21	Rueda LED PIR 120 Motion Sensor Light	10 V DC	white	3000 K	IP 20	MJ-RUE-C-H
21	Rueda LED PIR 120 Motion Sensor Light	10 V DC	white	blue	IP 20	MJ-RUE-C-B
21	Rueda LED PIR 120 Motion Sensor Light	230 V AC	stainless steel	6000 K	IP 20	MM-RUE-K-W
21	Rueda LED PIR 120 Motion Sensor Light	230 V AC	stainless steel	4000 K	IP 20	MM-RUE-K-N
21	Rueda LED PIR 120 Motion Sensor Light	230 V AC	stainless steel	3000 K	IP 20	MM-RUE-K-H
21	Rueda LED PIR 120 Motion Sensor Light	230 V AC	stainless steel	blue	IP 20	MM-RUE-K-B
21	Rueda LED PIR 120 Motion Sensor Light	230 V AC	aluminium	6000 K	IP 20	MM-RUE-G-W
21	Rueda LED PIR 120 Motion Sensor Light	230 V AC	aluminium	4000 K	IP 20	MM-RUE-G-N
21	Rueda LED PIR 120 Motion Sensor Light	230 V AC	aluminium	3000 K	IP 20	MM-RUE-G-H
21	Rueda LED PIR 120 Motion Sensor Light	230 V AC	aluminium	blue	IP 20	MM-RUE-G-B
21	Rueda LED PIR 120 Motion Sensor Light	230 V AC	black	6000 K	IP 20	MM-RUE-D-W
21	Rueda LED PIR 120 Motion Sensor Light	230 V AC	black	4000 K	IP 20	MM-RUE-D-N
21	Rueda LED PIR 120 Motion Sensor Light	230 V AC	black	3000 K	IP 20	MM-RUE-D-H
21	Rueda LED PIR 120 Motion Sensor Light	230 V AC	black	blue	IP 20	MM-RUE-D-B
21	Rueda LED PIR 120 Motion Sensor Light	230 V AC	white	6000 K	IP 20	MM-RUE-C-W
21	Rueda LED PIR 120 Motion Sensor Light	230 V AC	white	4000 K	IP 20	MM-RUE-C-N
21	Rueda LED PIR 120 Motion Sensor Light	230 V AC	white	3000 K	IP 20	MM-RUE-C-H
21	Rueda LED PIR 120 Motion Sensor Light	230 V AC	white	blue	IP 20	MM-RUE-C-B
22	Rueda LED Light	10 V DC	stainless steel	6000 K	IP 20	ML-RUE-K-W
22	Rueda LED Light	10 V DC	stainless steel	4000 K	IP 20	ML-RUE-K-N
22	Rueda LED Light	10 V DC	stainless steel	3000 K	IP 20	ML-RUE-K-H
22	Rueda LED Light	10 V DC	stainless steel	blue	IP 20	ML-RUE-K-B
22	Rueda LED Light	10 V DC	aluminium	6000 K	IP 20	ML-RUE-G-W
22	Rueda LED Light	10 V DC	aluminium	4000 K	IP 20	ML-RUE-G-N
22	Rueda LED Light	10 V DC	aluminium	3000 K	IP 20	ML-RUE-G-H
22	Rueda LED Light	10 V DC	aluminium	blue	IP 20	ML-RUE-G-B
22	Rueda LED Light	10 V DC	black	6000 K	IP 20	ML-RUE-D-W
22	Rueda LED Light	10 V DC	black	4000 K	IP 20	ML-RUE-D-N
22	Rueda LED Light	10 V DC	black	3000 K	IP 20	ML-RUE-D-H
22	Rueda LED Light	10 V DC	black	blue	IP 20	ML-RUE-D-B
22	Rueda LED Light	10 V DC	white	6000 K	IP 20	ML-RUE-C-W
22	Rueda LED Light	10 V DC	white	4000 K	IP 20	ML-RUE-C-N
22	Rueda LED Light	10 V DC	white	3000 K	IP 20	ML-RUE-C-H
22	Rueda LED Light	10 V DC	white	blue	IP 20	ML-RUE-C-B
22	Rueda LED Light	10 V DC	stainless steel	6000 K	IP 66	MH-RUE-K-W
22	Rueda LED Light	10 V DC	stainless steel	4000 K	IP 66	MH-RUE-K-N
22	Rueda LED Light	10 V DC	stainless steel	3000 K	IP 66	MH-RUE-K-H
22	Rueda LED Light	10 V DC	stainless steel	blue	IP 66	MH-RUE-K-B
22	Rueda LED Light	10 V DC	aluminium	6000 K	IP 66	MH-RUE-G-W
22	Rueda LED Light	10 V DC	aluminium	4000 K	IP 66	MH-RUE-G-N
22	Rueda LED Light	10 V DC	aluminium	3000 K	IP 66	MH-RUE-G-H
22	Rueda LED Light	10 V DC	aluminium	blue	IP 66	MH-RUE-G-B
22	Rueda LED Light	10 V DC	black	6000 K	IP 66	MH-RUE-D-W
22	Rueda LED Light	10 V DC	black	4000 K	IP 66	MH-RUE-D-N
22	Rueda LED Light	10 V DC	black	3000 K	IP 66	MH-RUE-D-H
22	Rueda LED Light	10 V DC	black	blue	IP 66	MH-RUE-D-B
22	Rueda LED Light	10 V DC	white	6000 K	IP 66	MH-RUE-C-W
22	Rueda LED Light	10 V DC	white	4000 K	IP 66	MH-RUE-C-N
22	Rueda LED Light	10 V DC	white	3000 K	IP 66	MH-RUE-C-H
22	Rueda LED Light	10 V DC	white	blue	IP 66	MH-RUE-C-B
22	Rueda LED Light	230 V AC	stainless steel	6000 K	IP 20	MA-RUE-K-W
22	Rueda LED Light	230 V AC	stainless steel	4000 K	IP 20	MA-RUE-K-N
22	Rueda LED Light	230 V AC	stainless steel	3000 K	IP 20	MA-RUE-K-H
22	Rueda LED Light	230 V AC	stainless steel	blue	IP 20	MA-RUE-K-B
22	Rueda LED Light	230 V AC	aluminium	6000 K	IP 20	MA-RUE-G-W
22	Rueda LED Light	230 V AC	aluminium	4000 K	IP 20	MA-RUE-G-N
22	Rueda LED Light	230 V AC	aluminium	3000 K	IP 20	MA-RUE-G-H
22	Rueda LED Light	230 V AC	aluminium	blue	IP 20	MA-RUE-G-B
22	Rueda LED Light	230 V AC	black	6000 K	IP 20	MA-RUE-D-W
22	Rueda LED Light	230 V AC	black	4000 K	IP 20	MA-RUE-D-N
22	Rueda LED Light	230 V AC	black	3000 K	IP 20	MA-RUE-D-H
22	Rueda LED Light	230 V AC	black	blue	IP 20	MA-RUE-D-B
22	Rueda LED Light	230 V AC	white	6000 K	IP 20	MA-RUE-C-W
22	Rueda LED Light	230 V AC	white	4000 K	IP 20	MA-RUE-C-N
22	Rueda LED Light	230 V AC	white	3000 K	IP 20	MA-RUE-C-H
22	Rueda LED Light	230 V AC	white	blue	IP 20	MA-RUE-C-B
23	Rueda PIR 120 Motion Sensor	10 V DC	stainless steel		IP 20	MC-RUE-K-0
23	Rueda PIR 120 Motion Sensor	10 V DC	aluminium		IP 20	MC-RUE-G-0
23	Rueda PIR 120 Motion Sensor	10 V DC	black		IP 20	MC-RUE-D-0
23	Rueda PIR 120 Motion Sensor	10 V DC	white		IP 20	MC-RUE-C-0
23	Rueda PIR 120 Motion Sensor	230 V AC	stainless steel		IP 20	MD-RUE-K-0
23	Rueda PIR 120 Motion Sensor	230 V AC	aluminium		IP 20	MD-RUE-G-0
23	Rueda PIR 120 Motion Sensor	230 V AC	black		IP 20	MD-RUE-D-0
23	Rueda PIR 120 Motion Sensor	230 V AC	white		IP 20	MD-RUE-C-0
25	Rueda Short LED PIR 120 Motion Sensor Light	10 V DC	stainless steel	6000 K	IP 20	MK-RUE-K-W
25	Rueda Short LED PIR 120 Motion Sensor Light	10 V DC	stainless steel	4000 K	IP 20	MK-RUE-K-N
25	Rueda Short LED PIR 120 Motion Sensor Light	10 V DC	stainless steel	3000 K	IP 20	MK-RUE-K-H
25	Rueda Short LED PIR 120 Motion Sensor Light	10 V DC	stainless steel	blue	IP 20	MK-RUE-K-B
25	Rueda Short LED PIR 120 Motion Sensor Light	10 V DC	aluminium	6000 K	IP 20	MK-RUE-G-W

Page	Description	Voltage	Finishing	Colour Temperature	Protection class	Index
25	Rueda Short LED PIR 120 Motion Sensor Light	10 V DC	aluminium	4000 K	IP 20	MK-RUE-G-N
25	Rueda Short LED PIR 120 Motion Sensor Light	10 V DC	aluminium	3000 K	IP 20	MK-RUE-G-H
25	Rueda Short LED PIR 120 Motion Sensor Light	10 V DC	aluminium	blue	IP 20	MK-RUE-G-B
25	Rueda Short LED PIR 120 Motion Sensor Light	10 V DC	black	6000 K	IP 20	MK-RUE-D-W
25	Rueda Short LED PIR 120 Motion Sensor Light	10 V DC	black	4000 K	IP 20	MK-RUE-D-N
25	Rueda Short LED PIR 120 Motion Sensor Light	10 V DC	black	3000 K	IP 20	MK-RUE-D-H
25	Rueda Short LED PIR 120 Motion Sensor Light	10 V DC	black	blue	IP 20	MK-RUE-D-B
25	Rueda Short LED PIR 120 Motion Sensor Light	10 V DC	white	6000 K	IP 20	MK-RUE-C-W
25	Rueda Short LED PIR 120 Motion Sensor Light	10 V DC	white	4000 K	IP 20	MK-RUE-C-N
25	Rueda Short LED PIR 120 Motion Sensor Light	10 V DC	white	3000 K	IP 20	MK-RUE-C-H
25	Rueda Short LED PIR 120 Motion Sensor Light	10 V DC	white	blue	IP 20	MK-RUE-C-B
25	Rueda Short LED PIR 120 Motion Sensor Light	230 V AC	stainless steel	6000 K	IP 20	MN-RUE-K-W
25	Rueda Short LED PIR 120 Motion Sensor Light	230 V AC	stainless steel	4000 K	IP 20	MN-RUE-K-N
25	Rueda Short LED PIR 120 Motion Sensor Light	230 V AC	stainless steel	3000 K	IP 20	MN-RUE-K-H
25	Rueda Short LED PIR 120 Motion Sensor Light	230 V AC	stainless steel	blue	IP 20	MN-RUE-K-B
25	Rueda Short LED PIR 120 Motion Sensor Light	230 V AC	aluminium	6000 K	IP 20	MN-RUE-G-W
25	Rueda Short LED PIR 120 Motion Sensor Light	230 V AC	aluminium	4000 K	IP 20	MN-RUE-G-N
25	Rueda Short LED PIR 120 Motion Sensor Light	230 V AC	aluminium	3000 K	IP 20	MN-RUE-G-H
25	Rueda Short LED PIR 120 Motion Sensor Light	230 V AC	aluminium	blue	IP 20	MN-RUE-G-B
25	Rueda Short LED PIR 120 Motion Sensor Light	230 V AC	black	6000 K	IP 20	MN-RUE-D-W
25	Rueda Short LED PIR 120 Motion Sensor Light	230 V AC	black	4000 K	IP 20	MN-RUE-D-N
25	Rueda Short LED PIR 120 Motion Sensor Light	230 V AC	black	3000 K	IP 20	MN-RUE-D-H
25	Rueda Short LED PIR 120 Motion Sensor Light	230 V AC	black	blue	IP 20	MN-RUE-D-B
25	Rueda Short LED PIR 120 Motion Sensor Light	230 V AC	white	6000 K	IP 20	MN-RUE-C-W
25	Rueda Short LED PIR 120 Motion Sensor Light	230 V AC	white	4000 K	IP 20	MN-RUE-C-N
25	Rueda Short LED PIR 120 Motion Sensor Light	230 V AC	white	3000 K	IP 20	MN-RUE-C-H
25	Rueda Short LED PIR 120 Motion Sensor Light	230 V AC	white	blue	IP 20	MN-RUE-C-B
27	Rueda Short LED Light	10 V DC	stainless steel	6000 K	IP 20	MI-RUE-K-W
27	Rueda Short LED Light	10 V DC	stainless steel	4000 K	IP 20	MI-RUE-K-N
27	Rueda Short LED Light	10 V DC	stainless steel	3000 K	IP 20	MI-RUE-K-H
27	Rueda Short LED Light	10 V DC	stainless steel	blue	IP 20	MI-RUE-K-B
27	Rueda Short LED Light	10 V DC	aluminium	6000 K	IP 20	MI-RUE-G-W
27	Rueda Short LED Light	10 V DC	aluminium	4000 K	IP 20	MI-RUE-G-N
27	Rueda Short LED Light	10 V DC	aluminium	3000 K	IP 20	MI-RUE-G-H
27	Rueda Short LED Light	10 V DC	aluminium	blue	IP 20	MI-RUE-G-B
27	Rueda Short LED Light	10 V DC	black	6000 K	IP 20	MI-RUE-D-W
27	Rueda Short LED Light	10 V DC	black	4000 K	IP 20	MI-RUE-D-N
27	Rueda Short LED Light	10 V DC	black	3000 K	IP 20	MI-RUE-D-H
27	Rueda Short LED Light	10 V DC	black	blue	IP 20	MI-RUE-D-B
27	Rueda Short LED Light	10 V DC	white	6000 K	IP 20	MI-RUE-C-W
27	Rueda Short LED Light	10 V DC	white	4000 K	IP 20	MI-RUE-C-N
27	Rueda Short LED Light	10 V DC	white	3000 K	IP 20	MI-RUE-C-H
27	Rueda Short LED Light	10 V DC	white	blue	IP 20	MI-RUE-C-B
27	Rueda Short LED Light	10 V DC	stainless steel	6000 K	IP 66	MS-RUE-K-W
27	Rueda Short LED Light	10 V DC	stainless steel	4000 K	IP 66	MS-RUE-K-N
27	Rueda Short LED Light	10 V DC	stainless steel	3000 K	IP 66	MS-RUE-K-H
27	Rueda Short LED Light	10 V DC	stainless steel	blue	IP 66	MS-RUE-K-B
27	Rueda Short LED Light	10 V DC	aluminium	6000 K	IP 66	MS-RUE-G-W
27	Rueda Short LED Light	10 V DC	aluminium	4000 K	IP 66	MS-RUE-G-N
27	Rueda Short LED Light	10 V DC	aluminium	3000 K	IP 66	MS-RUE-G-H
27	Rueda Short LED Light	10 V DC	aluminium	blue	IP 66	MS-RUE-G-B
27	Rueda Short LED Light	10 V DC	black	6000 K	IP 66	MS-RUE-D-W
27	Rueda Short LED Light	10 V DC	black	4000 K	IP 66	MS-RUE-D-N
27	Rueda Short LED Light	10 V DC	black	3000 K	IP 66	MS-RUE-D-H
27	Rueda Short LED Light	10 V DC	black	blue	IP 66	MS-RUE-D-B
27	Rueda Short LED Light	10 V DC	white	6000 K	IP 66	MS-RUE-C-W
27	Rueda Short LED Light	10 V DC	white	4000 K	IP 66	MS-RUE-C-N
27	Rueda Short LED Light	10 V DC	white	3000 K	IP 66	MS-RUE-C-H
27	Rueda Short LED Light	10 V DC	white	blue	IP 66	MS-RUE-C-B
27	Rueda Short LED Light	230 V AC	stainless steel	6000 K	IP 20	MB-RUE-K-W
27	Rueda Short LED Light	230 V AC	stainless steel	4000 K	IP 20	MB-RUE-K-N
27	Rueda Short LED Light	230 V AC	stainless steel	3000 K	IP 20	MB-RUE-K-H
27	Rueda Short LED Light	230 V AC	stainless steel	blue	IP 20	MB-RUE-K-B
27	Rueda Short LED Light	230 V AC	aluminium	6000 K	IP 20	MB-RUE-G-W
27	Rueda Short LED Light	230 V AC	aluminium	4000 K	IP 20	MB-RUE-G-N
27	Rueda Short LED Light	230 V AC	aluminium	3000 K	IP 20	MB-RUE-G-H
27	Rueda Short LED Light	230 V AC	aluminium	blue	IP 20	MB-RUE-G-B
27	Rueda Short LED Light	230 V AC	black	6000 K	IP 20	MB-RUE-D-W
27	Rueda Short LED Light	230 V AC	black	4000 K	IP 20	MB-RUE-D-N
27	Rueda Short LED Light	230 V AC	black	3000 K	IP 20	MB-RUE-D-H
27	Rueda Short LED Light	230 V AC	black	blue	IP 20	MB-RUE-D-B
27	Rueda Short LED Light	230 V AC	white	6000 K	IP 20	MB-RUE-C-W
27	Rueda Short LED Light	230 V AC	white	4000 K	IP 20	MB-RUE-C-N
27	Rueda Short LED Light	230 V AC	white	3000 K	IP 20	MB-RUE-C-H
27	Rueda Short LED Light	230 V AC	white	blue	IP 20	MB-RUE-C-B
29	Salsa LED PIR 120 Motion Sensor Light	10 V DC	brass	4000 K	IP 20	MJ-SAL-M-N
29	Salsa LED PIR 120 Motion Sensor Light	10 V DC	brass	3000 K	IP 20	MJ-SAL-M-H
29	Salsa LED PIR 120 Motion Sensor Light	230 V AC	brass	4000 K	IP 20	MM-SAL-M-N
29	Salsa LED PIR 120 Motion Sensor Light	230 V AC	brass	3000 K	IP 20	MM-SAL-M-H
30	Salsa LED Light	10 V DC	brass	4000 K	IP 20	ML-SAL-M-N
30	Salsa LED Light	10 V DC	brass	3000 K	IP 20	ML-SAL-M-H
30	Salsa LED Light	10 V DC	brass	4000 K	IP 66	MH-SAL-M-N
30	Salsa LED Light	10 V DC	brass	3000 K	IP 66	MH-SAL-M-H
30	Salsa LED Light	230 V AC	brass	4000 K	IP 20	MA-SAL-M-N
30	Salsa LED Light	230 V AC	brass	3000 K	IP 20	MA-SAL-M-H
31	Salsa PIR 120 Motion Sensor	10 V DC	brass		IP 20	MC-SAL-M-0

Page	Description	Voltage	Finishing	Colour Temperature	Protection class	Index
31	Salsa PIR 120 Motion Sensor	230 V AC	brass		IP 20	MD-SAL-M-0
32	Salsa Short LED PIR 120 Motion Sensor Light	10 V DC	brass	4000 K	IP 20	MK-SAL-M-N
32	Salsa Short LED PIR 120 Motion Sensor Light	10 V DC	brass	3000 K	IP 20	MK-SAL-M-H
32	Salsa Short LED PIR 120 Motion Sensor Light	230 V AC	brass	4000 K	IP 20	MN-SAL-M-N
32	Salsa Short LED PIR 120 Motion Sensor Light	230 V AC	brass	3000 K	IP 20	MN-SAL-M-H
33	Salsa Short LED Light	10 V DC	brass	4000 K	IP 20	MI-SAL-M-N
33	Salsa Short LED Light	10 V DC	brass	3000 K	IP 20	MI-SAL-M-H
33	Salsa Short LED Light	10 V DC	brass	4000 K	IP 66	MS-SAL-M-N
33	Salsa Short LED Light	10 V DC	brass	3000 K	IP 66	MS-SAL-M-H
33	Salsa Short LED Light	230 V AC	brass	4000 K	IP 20	MB-SAL-M-N
33	Salsa Short LED Light	230 V AC	brass	3000 K	IP 20	MB-SAL-M-H

34	Power supplier ZOL7-10					ZL-007-C-1-1-ML-PL-01
34	Power supplier ZOL15-10					ZL-015-C-1-1-ML-PL-01
34	Junction box P60					AO-PEI-6-B-2-00-00-01
34	Power supplier ZOL 6					ZL-006-C-1-1-ML-PL-01
34	Power supplier ZOL 16					ZL-016-C-1-1-ML-PL-01
34	Power supplier ZOL 19-10					ZL-019-C-1-1-ML-PL-01

PRZYKŁADOWY SCHEMAT POŁĄCZENIA ELEKTRYCZNEGO

Electrical circuit example / Beispiel für einen Elektroanschluss



The total power of installed ML luminaires may not exceed the power rating of the power supply transformer.

Łączna moc zastosowanych opraw ML nie może przekraczać mocy znamionowej transformatora zasilającego.

Die gesamte Leistung der eingesetzten ML-Leuchten darf die Nennleistung des Transformators nicht übersteigen.

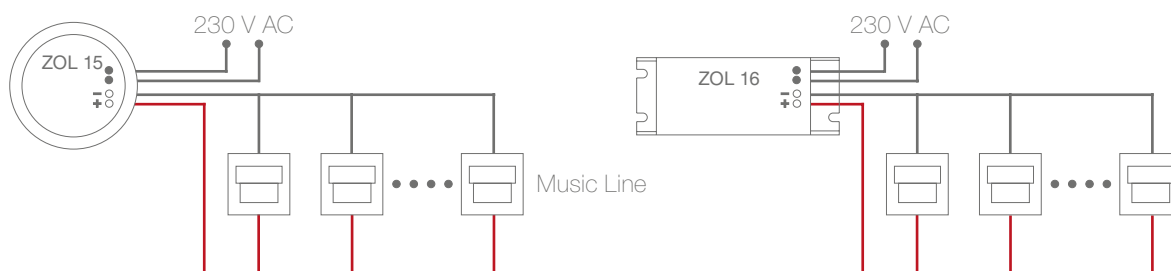

LEGAL NOTICE

This publication has been prepared by SKOFF Sp. z o.o. We reserve the right to make product changes. We have made every effort to ensure that the product photos and drawings included in the catalog correspond to the actual products, however we are not responsible for print errors.

The presented publication is not an offer within the meaning of the Civil Code. General terms and conditions as well as information on the terms and conditions of the guarantee can be found at www.skoff.pl or are specified in commercial contracts. Any infringement of copyrights through the use of photographs, graphic or text marks without the written consent of the publisher will be resolved by court proceedings.

NOTA PRAWNA

Niniejsza publikacja została przygotowana przez SKOFF Sp. z o.o. Zastrzegamy sobie prawo do wprowadzania zmian produktowych. Dołożyliśmy wszelkich starań, by zdjęcia produktowe i rysunki zamieszczone w katalogu jak najbardziej odpowiadały rzeczywistym produktom, jednakże nie ponosimy odpowiedzialności za błędy wynikające z druku.

Prezentowana publikacja nie jest ofertą w rozumieniu Kodeksu Cywilnego. Ogólne warunki handlowe oraz informacje dotyczące warunków gwarancji znajdują się na stronie www.skoff.pl lub sprecyzowane są w umowach handlowych. Wszelkie naruszanie praw autorskich poprzez wykorzystywanie zdjęć, znaków graficznych lub tekstowych bez pisemnej zgody wydawcy będzie rozwiązywane na drodze postępowania sądowego.

IMPRESSUM

Diese Publikation wurde von SKOFF Sp. z o.o. Wir behalten uns das Recht vor, Produktänderungen vorzunehmen. Wir haben uns bemüht sicherzustellen, dass die im Katalog enthaltenen Produktfotos und -zeichnungen den tatsächlichen Produkten entsprechen. Für Druckfehler sind wir jedoch nicht verantwortlich.

Die vorgestellte Veröffentlichung ist kein Angebot im Sinne des Zivilgesetzbuches. Allgemeine Geschäftsbedingungen sowie Informationen zu den Garantiebedingungen finden Sie unter www.skoff.pl oder sind in Handelsverträgen festgelegt. Jegliche Verletzung von Urheberrechten durch Verwendung von Fotografien, Grafiken oder Textmarken ohne die schriftliche Zustimmung des Herausgebers wird durch ein Gerichtsverfahren behoben.

© SKOFF 2019

We protect our intellectual property rights. • Chronimy nasze prawa własności intelektualnej. • Wir schützen unsere Rechte an geistigem Eigentum. We reserve the right to make changes and mistakes. • Zastrzegamy sobie prawo do zmian i błędów. • Änderungen und Irrtümer behalten wir uns vor.

SKOFF

43-500 Czechowice-Dziedzice
ul. Legionów 243d
Poland

tel. +48 32 215 28 93
fax. +48 32 215 65 05



www.skoff.pl
info@skoff.pl