

Venus PL4/2

Venus PL4/2 K

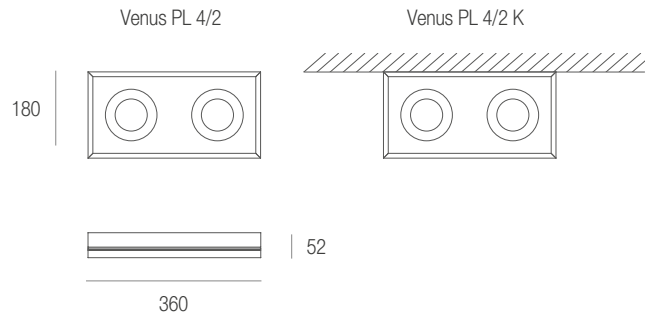

Specifications • Parametry techniczne • Technische Parameter

INDEX	Icon	W	Beam	CCT	lm	lm/W	IP	KG	RF	DALI	RF
GLVE2 □ W3MLML02		12 W	W	6000 K	1060	88	40	0,92	-	-	-
GLVE2 □ W3MLML08		12 W	W	6000 K	1060	88	40	0,95	☑	-	☑
GLVE2 □ W3MLML06		12 W	W	6000 K	1060	88	40	1,14	-	☑	-
GLVE2 □ H3MLML02		12 W	WW	3000 K	1010	84	40	0,92	-	-	-
GLVE2 □ H3MLML08		12 W	WW	3000 K	1010	84	40	0,95	☑	-	☑
GLVE2 □ H3MLML06		12 W	WW	3000 K	1010	84	40	1,14	-	☑	-
GLVE2 □ N3MLML02		12 W	N	4000 K	1060	88	40	0,92	-	-	-
GLVE2 □ N3MLML08		12 W	N	4000 K	1060	88	40	0,95	☑	-	☑
GLVE2 □ N3MLML06		12 W	N	4000 K	1060	88	40	1,14	-	☑	-
GLVE2 □ M3MLML08		12 W	M	3000 » 6000 K	max 1060	88	40	0,95	☑	-	☑
GLVE2 □ M3MLML06		12 W	M	3000 » 6000 K	max 1060	88	40	1,14	-	☑	-
GLVK2 □ W3MLML02		12 W	W	6000 K	1060	88	20	0,92	-	-	-
GLVK2 □ W3MLML08		12 W	W	6000 K	1060	88	20	0,95	☑	-	☑
GLVK2 □ W3MLML06		12 W	W	6000 K	1060	88	20	1,14	-	☑	-
GLVK2 □ H3MLML02		12 W	WW	3000 K	1010	84	20	0,92	-	-	-
GLVK2 □ H3MLML08		12 W	WW	3000 K	1010	84	20	0,95	☑	-	☑
GLVK2 □ H3MLML06		12 W	WW	3000 K	1010	84	20	1,14	-	☑	-
GLVK2 □ N3MLML02		12 W	N	4000 K	1060	88	20	0,92	-	-	-
GLVK2 □ N3MLML08		12 W	N	4000 K	1060	88	20	0,95	☑	-	☑
GLVK2 □ N3MLML06		12 W	N	4000 K	1060	88	20	1,14	-	☑	-
GLVK2 □ M3MLML08		12 W	M	3000 » 6000 K	max 1060	88	20	0,95	☑	-	☑
GLVK2 □ M3MLML06		12 W	M	3000 » 6000 K	max 1060	88	20	1,14	-	☑	-

Finishing • Wykończenie • Verarbeitungsart:

- G Aluminium • Aluminium • Aluminium
- D Black • Czarny • Schwarz
- C White • Biały • Weiß

Use

For general lighting in offices, schools and shops.

Further information

Material: aluminium, glass

Light source: non-exchangeable LED modules

Method of installation:

 - directly on ceiling surface

 - directly on wall surface

Lifespan: 50.000 h (L70B50)

Warranty: 36 months + 24 months after project registration

Finishing • Wykończenie • Verarbeitungsart



Colour of light • Barwa światła • Lichtfarbe



Zastosowanie

Do oświetlenia ogólnego w biurach, szkołach lub w sklepach.

Informacje dodatkowe

Materiał: aluminium, szkło

Źródło światła: niewymienne moduły LED

Sposób montażu:

 - bezpośrednio na powierzchni sufitu

 - bezpośrednio na powierzchni ściany

Żywotność: 50.000 h (L70B50)

Gwarancja: 36 miesięcy + 24 miesiące po rejestracji produktu

Photometry • Fotometria • Photometrie

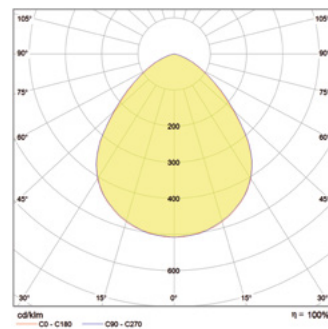

Verwendung

Für die allgemeine Beleuchtung in Büros, Schulen oder Läden.

Zusätzliche Angaben

Material: Aluminium, Glas

Leuchtmittel: nicht austauschbare LED-Module

Montage:

 - direkt an der Deckenoberfläche

 - direkt an der Wandoberfläche

Lebensdauer: 50.000 h (L70B50)

Garantie: 36 Monate + 24 Monate nach Projektregistrierung

Standards • Normy • Normen

PN-EN 60598-1:2015-04, PN-EN 62031:2010/A2:2015-04,

PN-EN 60598-2:2012, PN-EN 62031:2010/A1:2013-06

PN-EN 62471:2010, PN-EN 55015:2013-10

PN-EN 62031:2010,

Energy efficiency class • Klasa energetyczna • Energieklasse:

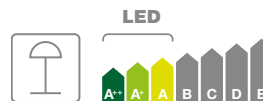

Legend

Objaśnienia znaków • Legende

Installation • Montaż • Montage



Cabinet mounted lighting with wide beam angle
Oświetlenie meblowe do zabudowy z szerokim kątem świecenia
Beleuchtung mit breitem Lichtwinkel für die Einbaumöbel



Cabinet mounted lighting with narrow beam angle
Oświetlenie meblowe do zabudowy z wąskim kątem świecenia
Beleuchtung mit schmalem Lichtwinkel für die Einbaumöbel



Cabinet top-mounted lighting with wide beam angle
Oświetlenie meblowe do nadbudowy z szerokim kątem świecenia
Beleuchtung mit breitem Lichtwinkel für die Aufbaumöbel



Overhead furniture lights
Oświetlenie meblowe do nadbudowy z wąskim kątem świecenia
Beleuchtung mit schmalem Lichtwinkel für die Aufbaumöbel



Furniture lights mounted on glazing
Oświetlenie meblowe do montażu na szybie
Furniture lights mounted on glazing



Built-in wide angle lights
Oświetlenie sufitowe do zabudowy z szerokim kątem świecenia
Einbauleuchten mit weitem Lichtwinkel



Overhead wide angle lights
Oświetlenie sufitowe do nadbudowy z szerokim kątem świecenia
Aufbauleuchten mit weitem Lichtwinkel



Wall-mounted wide angle lights
Oświetlenie ścienne z szerokim kątem świecenia
Wandleuchten mit weitem Lichtwinkel



Hanging wide angle lights
Oświetlenie sufitowe wiszące z szerokim kątem świecenia
Hängeleuchten mit weitem Lichtwinkel



Floor lighting with wide beam angle
Oświetlenie podłogowe z szerokim kątem świecenia
Bodenbeleuchtung mit breitem Lichtwinkel

Finishing • Wykończenie • Verarbeitungsart



Surface Finishing
Wykończenie powierzchni
Oberflächenverarbeitung



stainless steel (INOX)
Stal nierdzewna (INOX)
Edelstahl (INOX)



Chrome plating
Chrom
Chrom



White
Biały
Weiß



Black
Czarny
Schwarz



Aged brass
Mosiądz starzony
Altmessing



Aluminium
Aluminium
Aluminium



Brushed nickel (INOX)
Szczotkowany nikiel (INOX)
Nickel gebürstet (INOX)



Brushed stainless steel (INOX)
Szczotkowana stal nierdzewna (INOX)
Edelstahl gebürstet (INOX)



Mirror (INOX)
Lustro (INOX)
Spiegelblank (INOX)



Matte brass
Mosiądz mat
Messing matt



Champagne
Szampański
Champagne



Transparent
Przezroczysty
Transparent

Light specifications • Parametry świetlne

Licht-Spezifikationen



LED Light source
Źródło światła LED
LED-Leuchtmittel



Replaceable Light source
Wymienne źródło światła
Austauschbares Leuchtmittel



Colour of light
Barwa światła
Lichtfarbe



Blue
Niebieski
Blau



Neutral
Neutralny
Neutral



Kaltweiß
Zimny biały
cool white



White warm
Ciepły biały
Warmweiß



Colour rendering index
Współczynnik oddawania barw
Farbwiedergabeindex



Colour temperature
Temperatura barwowa
Farbtemperatur



The upper limit temperature of white colour
Górna granica temperatury koloru białego
Die obere Grenztemperatur der weißen Farbe



The lower limit temperature of white colour
Dolna granica temperatury koloru białego
Die untere Grenztemperatur der weißen Farbe



LED light flux
Strumień świetlny diody LED
LED-Lichtstrom





















Luminaire light flux
Strumień świetlny oprawy
Lichtstrom der Leuchte









Luminous efficacy luminaire
Skuteczność świetlna oprawy
Lichtausbeute der Leuchte

Specifications • Parametry techniczne















Technische Parameter

	Rated power Moc znamionowa Nennleistung
	LED power Moc diody LED LED-Leistung
	Fixture power Moc oprawy Leistung der Leuchte
	DC voltage Wartość napięcia prądu stałego Spannung Konstantstrom
	AC voltage Wartość napięcia prądu zmiennego Spannung Wechselstrom
	Energy efficiency class - LED Klasa efektywności energetycznej LED LED-Energieeffizienzklasse
	Energy efficiency class - replaceable light sources Klasa efektywności energetycznej - wymienne źródła światła Energieeffizienzklasse - austauschbare Leuchtmittel
	Tightness Szczelność Dichtheit
	Resistance Wytrzymałość Beständigkeit
	Protection class I I klasa ochronności Schutzklasse I
	Protection class II II klasa ochronności Schutzklasse II
	Protection class III III klasa ochronności Schutzklasse I
	Device independent of lamps Urządzenie niezależne od lamp Gerät unabhängig von Leuchten
	Short-circuit and overload proof safety transformer Transformator bezpieczeństwa odporny na zwarcia i przeciążenia. Sicherheitstransformator geschützt gegen Kurzschluss und Überlastung.
	SELV protection Ochrona SELV Schutzkleinspannung SELV
	Beam angle Kąt świecenia Lichtwinkel
	Min. distance from illuminated item Min. odległość od oświetlanego obiektu Mindestabstand zum beleuchteten Objekt
	Weight Waga Gewicht
	Single LED tape module dimensions Wymiar pojedynczego modułu taśmy LED Abmessungen des Einzelmoduls eines LED-Streifens

	Min. operating temperature Minimalna temperatura pracy Minimale Betriebstemperatur
	Max. operating temperature Maksymalna temperatura pracy Maximale Betriebstemperatur
	Constant current Stabilizacja prądowa (Constant Current) Stromstabilisierung (Constant Current)
	Constant voltage Stabilizacja napięciowa (Constant Voltage) Spannungstabilisierung (Constant Voltage)
	PF (Power Factor) Wartość PF (Power Factor) PF-Wert (Power Factor)
	Input voltage Napięcie wejściowe Eingangsspannung
	Output voltage Napięcie wyjściowe Ausgangsspannung

Performance parameters • Parametry użytkowe

Performance-Parameter

	Compatibility with SKOFF &More System Kompatybilność z systemem SKOFF &More Kompatibilität mit dem SKOFF & More System
	Compatibility with intelligent home systems Kompatybilność z systemami inteligentnego domu Kompatibel mit Smart-Home-Systemen
	Compatibility with DALI light controlling system Kompatybilność z systemami sterowania DALI Kompatibilität mit DALI Lichtregelsystem
	Dimming options Możliwość ściemniania Steuerung der Helligkeit
	No dimming Brak możliwości ściemniania Keine Steuerung der Helligkeit
	Możliwość zmiany barwy koloru emitowanego światła Emitting light colour change available Ausstrahlende helle Farbenänderung vorhanden
	Brak możliwości zmiany barwy koloru emitowanego światła Emitting light colour change not available Lichtaustritt ist nicht möglich
	Low glare index Niski współczynnik ośnienia Niedriger Blendungsindex
	Compliance with RoHS Zgodność z wymaganiami RoHS Entspricht den RoHS-Richtlinien
	Compliance with CE Directive Zgodność z dyrektywą CE Entspricht der CE-Richtlinie
	Compliance with WEEE Directive Zgodność z dyrektywą WEEE Entspricht der WEEE-Richtlinie
	Compliance with cRUus requirements Zgodność z wymaganiami cRUus Entspricht den cRUus-Anforderungen
	SKOFF item no. Numer indeksu SKOFF SKOFF Index-Nr.
	3M technology is implemented in the product W produkcji zastosowano technologię firmy 3M Im Produkt wurde die Technologie vom 3M-Konzern eingesetzt

© SKOFF 2017

We protect our Intellectual Property Rights • Chronimy nasze prawa własności intelektualnej • Wir schützen unsere Rechte am geistigen Eigentum.

We reserve our rights for technical modifications • Zastrzegamy sobie prawo do wprowadzania zmian technicznych • Technische Änderungen vorbehalten.