

# Tango Short

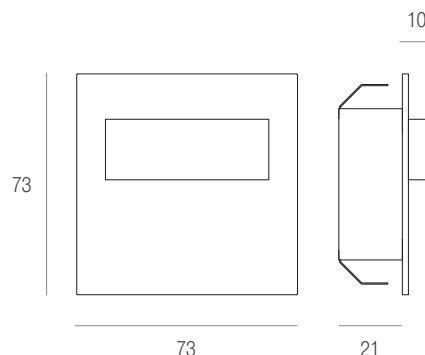

## Specifications • Parametry techniczne • Technische Parameter



INDEX										
MS-TAN-K-W-1-PL-00-01	K	0,8 W	W	6000 K	22	28	66	09	0,085	
MS-TAN-K-H-1-PL-00-01	K	0,8 W	WW	3800 K	21	26	66	09	0,085	
MS-TAN-K-B-1-PL-00-01	K	0,8 W	B	-	-	-	66	09	0,085	
MS-TAN-G-W-1-PL-00-01	G	0,8 W	W	6000 K	22	28	66	09	0,085	
MS-TAN-G-H-1-PL-00-01	G	0,8 W	WW	3800 K	21	26	66	09	0,085	
MS-TAN-G-B-1-PL-00-01	G	0,8 W	B	-	-	-	66	09	0,085	
MS-TAN-D-W-1-PL-00-01	D	0,8 W	W	6000 K	22	28	66	09	0,085	
MS-TAN-D-H-1-PL-00-01	D	0,8 W	WW	3800 K	21	26	66	09	0,085	
MS-TAN-D-B-1-PL-00-01	D	0,8 W	B	-	-	-	66	09	0,085	
MS-TAN-C-W-1-PL-00-01	C	0,8 W	W	6000 K	22	28	66	09	0,085	
MS-TAN-C-H-1-PL-00-01	C	0,8 W	WW	3800 K	21	26	66	09	0,085	
MS-TAN-C-B-1-PL-00-01	C	0,8 W	B	-	-	-	66	09	0,085	

### Use

For illumination of circulation routes, stairs, stair risers, cabinet fronts, or for attractive light decoration of walls.

### Further information

**Material:** stainless steel (INOX), aluminium  
**Light source:** non-exchangeable LED modules  
**Method of installation:** back box Ø 60 mm  
**Warranty:** 36 months

### Zastosowanie

Do oświetlenia ciągów komunikacyjnych, schodów, podstopnic, witryn meblowych, lub do efektownego dekorowanie światłem ścian.

### Informacje dodatkowe

**Material:** stal szlachetna (INOX), aluminium  
**Źródło światła:** niewymienne moduły LED  
**Sposób montażu:** w puszcze Ø 60 mm  
**Gwarancja:** 36 miesięcy

### Verwendung

Für die Beleuchtung der Verkehrsstränge, Treppen, Setzstufen, Vitrinen oder für eine effektvolle dekorative Wandbeleuchtung.

### Zusätzliche Angaben

**Material:** Edelstahl (INOX), Aluminium  
**Leuchtmittel:** nicht austauschbare LED-Module  
**Montage:** in einer Installationsdose Ø 60 mm  
**Garantie:** 36 Monate

Finishing • Wykończenie • Verarbeitungsart



Colour of light • Barwa światła • Lichtfarbe



Photometry • Fotometria • Photometrie

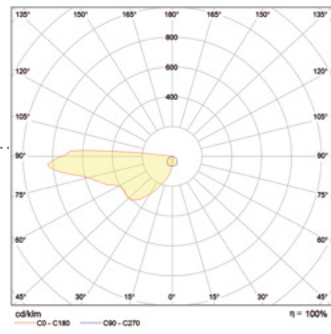

Standards • Normy • Normen

PN-EN 60598-1:2015-04, PN-EN 62031:2010/A2:2015-04,  
PN-EN 60598-2:2012, PN-EN 62031:2010/A1:2013-06  
PN-EN 62471:2010,  
PN-EN 62031:2010,

Energy efficiency class • Klasa energetyczna •  
Energieklasse:

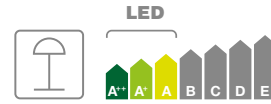

























# Legend

Objaśnienia znaków • Legende

## Installation • Montaż • Montage















	Cabinet mounted lighting with wide beam angle Oświetlenie meblowe do zabudowy z szerokim kątem świecenia Beleuchtung mit breitem Lichtwinkel für die Einbaumöbel
	Cabinet mounted lighting with narrow beam angle Oświetlenie meblowe do zabudowy z wąskim kątem świecenia Beleuchtung mit schmalem Lichtwinkel für die Einbaumöbel
	Cabinet top-mounted lighting with wide beam angle Oświetlenie meblowe do nadbudowy z szerokim kątem świecenia Beleuchtung mit breitem Lichtwinkel für die Aufbaumöbel
	Overhead furniture lights Oświetlenie meblowe do nadbudowy z wąskim kątem świecenia Beleuchtung mit schmalem Lichtwinkel für die Aufbaumöbel
	Furniture lights mounted on glazing Oświetlenie meblowe do montażu na szybie Furniture lights mounted on glazing
	Built-in wide angle lights Oświetlenie sufitowe do zabudowy z szerokim kątem świecenia Einbauleuchten mit weitem Lichtwinkel
	Overhead wide angle lights Oświetlenie sufitowe do nadbudowy z szerokim kątem świecenia Aufbauleuchten mit weitem Lichtwinkel
	Wall-mounted wide angle lights Oświetlenie ścienne z szerokim kątem świecenia Wandleuchten mit weitem Lichtwinkel
	Hanging wide angle lights Oświetlenie wiszące z szerokim kątem świecenia Hängeleuchten mit weitem Lichtwinkel
	Floor lighting with wide beam angle Oświetlenie podłogowe z szerokim kątem świecenia Bodenbeleuchtung mit breitem Lichtwinkel

## Finishing • Wykończenie • Verarbeitungsart

	Surface Finishing Wykończenie powierzchni Oberflächenverarbeitung
	stainless steel (INOX) Stal nierdzewna (INOX) Edelstahl (INOX)
	Chrome plating Chrom Chrom
	White Biały Weiß
	Black Czarny Schwarz
	Aged brass Mosiądz starzony Altmessing
	Aluminium Aluminium Aluminium
	Brushed nickel (INOX) Szczotkowany nikiel (INOX) Nickel gebürstet (INOX)
	Brushed stainless steel (INOX) Szczotkowana stal nierdzewna (INOX) Edelstahl gebürstet (INOX)
	Mirror (INOX) Lustro (INOX) Spiegelblank (INOX)
	Matte brass Mosiądz mat Messing matt
	Champagne Szampański Champagne
	Transparent Przezroczysty Transparent



















## Light specifications • Parametry świetlne







### Licht-Spezifikationen

	LED Light source Źródło światła LED LED-Leuchtmittel
	Replaceable Light source Wymienne źródło światła Austauschbares Leuchtmittel
	Colour of light Barwa światła Lichtfarbe
	Blue Niebieski Blau
	Neutral Neutralny Neutral
	Kaltweiß Zimny biały cool white
	White warm Ciepły biały Warmweiß
	Colour rendering index Współczynnik oddawania barw Farbwiedergabeindex
	Colour temperature Temperatura barwowa Farbtemperatur
	The upper limit temperature of white colour Górna granica temperatury koloru białego Die obere Grenztemperatur der weißen Farbe
	The lower limit temperature of white colour Dolna granica temperatury koloru białego Die untere Grenztemperatur der weißen Farbe
	LED light flux Strumień świetlny diody LED LED-Lichtstrom
	Luminaire light flux Strumień świetlny oprawy Lichtstrom der Leuchte
	Luminous efficacy luminaire Skuteczność świetlna oprawy Lichtausbeute der Leuchte

## Specifications • Parametry techniczne













### Technische Parameter

	Rated power Moc znamionowa Nennleistung
	LED power Moc diody LED LED-Leistung
	Fixture power Moc oprawy Leistung der Leuchte
	DC voltage Wartość napięcia prądu stałego Spannung Konstantstrom
	AC voltage Wartość napięcia prądu zmiennego Spannung Wechselstrom
	Energy efficiency class - LED Klasa efektywności energetycznej LED LED-Energieeffizienzklasse
	Energy efficiency class - replaceable light sources Klasa efektywności energetycznej - wymienne źródła światła Energieeffizienzklasse - austauschbare Leuchtmittel
	Tightness Szczelność Dichtheit
	Resistance Wytrzymałość Beständigkeit
	Protection class I I klasa ochronności Schutzklasse I
	Protection class II II klasa ochronności Schutzklasse II
	Protection class III III klasa ochronności Schutzklasse I
	Device independent of lamps Urządzenie niezależne od lamp Gerät unabhängig von Leuchten
	Short-circuit and overload proof safety transformer Transformator bezpieczeństwa odporny na zwarcia i przeciążenia. Sicherheitstransformator geschützt gegen Kurzschluss und Überlastung.
	SELV protection Ochrona SELV Schutzkleinspannung SELV
	Beam angle Kąt świecenia Lichtwinkel
	Min. distance from illuminated item Min. odległość od oświetlanego obiektu Mindestabstand zum beleuchteten Objekt
	Weight Waga Gewicht
	Single LED tape module dimensions Wymiar pojedynczego modułu taśmy LED Abmessungen des Einzelmoduls eines LED-Streifens

	Min. operating temperature Minimalna temperatura pracy Minimale Betriebstemperatur
	Max. operating temperature Maksymalna temperatura pracy Maximale Betriebstemperatur
	Constant current Stabilizacja prądowa (Constant Current) Stromstabilisierung (Constant Current)
	Constant voltage Stabilizacja napięciowa (Constant Voltage) Spannungstabilisierung (Constant Voltage)
	PF (Power Factor) Wartość PF (Power Factor) PF-Wert (Power Factor)
	Input voltage Napięcie wejściowe Eingangsspannung
	Output voltage Napięcie wyjściowe Ausgangsspannung

## Performance parameters • Parametry użytkowe

### Performance-Parameter

	Compatibility with SKOFF &More System Kompatybilność z systemem SKOFF &More Kompatibilität mit dem SKOFF & More System
	Compatibility with intelligent home systems Kompatybilność z systemami inteligentnego domu Kompatibel mit Smart-Home-Systemen
	Compatibility with DALI light controlling system Kompatybilność z systemami sterowania DALI Kompatibilität mit DALI Lichtregelsystem
	Dimming options Możliwość ściemniania Steuerung der Helligkeit
	No dimming Brak możliwości ściemniania Keine Steuerung der Helligkeit
	Możliwość zmiany barwy koloru emitowanego światła Emitting light colour change available Ausstrahlende helle Farbenänderung vorhanden
	Brak możliwości zmiany barwy koloru emitowanego światła Emitting light colour change not available Lichtaustritt ist nicht möglich
	Low glare index Niski współczynnik ośnienia Niedriger Blendungsindex
	Compliance with RoHS Zgodność z wymaganiami RoHS Entspricht den RoHS-Richtlinien
	Compliance with CE Directive Zgodność z dyrektywą CE Entspricht der CE-Richtlinie
	Compliance with WEEE Directive Zgodność z dyrektywą WEEE Entspricht der WEEE-Richtlinie
	Compliance with cRUus requirements Zgodność z wymaganiami cRUus Entspricht den cRUus-Anforderungen
	SKOFF item no. Numer indeksu SKOFF SKOFF Index-Nr.
	3M technology is implemented in the product W produkcji zastosowano technologię firmy 3M Im Produkt wurde die Technologie vom 3M-Konzern eingesetzt

© SKOFF 2017

We protect our Intellectual Property Rights • Chronimy nasze prawa własności intelektualnej • Wir schützen unsere Rechte am geistigen Eigentum.

We reserve our rights for technical modifications • Zastrzegamy sobie prawo do wprowadzania zmian technicznych • Technische Änderungen vorbehalten.